

**Indin, s.r.o.**  
Zámostní 1155/27  
710 00 Ostrava  
Czech republic

Eshop: <https://www.lockey.cz/>



## LOCKOUT TAGOUT SOLUTION >> 10.0

Lock out, stay safe.





		<b>SAFETY PADLOCK</b>	01-12
		<b>VALVE LOCKOUT</b>	13-21
		<b>CABLE LOCKOUT</b>	22-26
		<b>CIRCUIT BREAKER LOCKOUT</b>	27-40
		<b>PNEUMATIC &amp; ELECTRICAL LOCKOUT</b>	41-50
		<b>LOCKOUT HASP</b>	51-56
		<b>LOCKOUT TAG</b>	57-58
		<b>LOCKOUT BOX &amp; STATION</b>	59-70
		<b>LOCKOUT KIT</b>	71-75

## SAFETY PADLOCKS

● Different shackle materials and heights for your choice:



● Different body shapes for your choice:



● Different body colors for your choice:





## PADLOCK PROFILE CHART

02

SAFETY PADLOCK

### Padlock Shackle:

- Steel Shackle: 25S, 38S, 76S
- Insulation Shackle: 25P, 38P, 76P, 38PD4
- Stainless Steel Shackle: 16SSD4, 38SS, 38SSD4
- Cable Shackle: C175D3.2, C175D1.5

### Padlock Body:

- Straight edge plastic lock body: P
- Arc edge plastic lock body: AP
- Striped plastic lock body: BP
- Lockey patented design lock body: CP

### Dangerous label:

The language can be customized.

### Key Retaining Feature:

When the shackle is open, the key can not be removed.

### Unique non-conductive lock cylinder:

The operation process is more secure by preventing electricity travelling from the shackle to the key.

With rewritable warning labels



### Features

- Reinforced nylon body, ensures the padlock strength and can't be deformed easily. The steel shackle padlock withstands temperature from  $-20^{\circ}\text{C}$  to  $+120^{\circ}\text{C}$ . The non-conductive shackle padlock withstands temperature from  $-20^{\circ}\text{C}$  to  $+120^{\circ}\text{C}$ .
- Widely used in chemical, electrical, automobile industry, etc.
- With rewritable warning signs, other designs can be customized.
- Resistance of chemical, extreme temperatures and UV rays.
- Key Retaining Feature: When the shackle is open, the key can't be removed.
- Laser printing and logo engraving is available if required.
- Several types of lock bodies and different colors available.

Eshop: <https://www.lockey.cz/>

## OEM SERVICE SUPPORTED

03

SAFETY PADLOCK



Other languages and designs



### Regular Shackles



### Regular lock bodies



Eshop: <https://www.lockey.cz/>



## KEY CHARTING SYSTEM

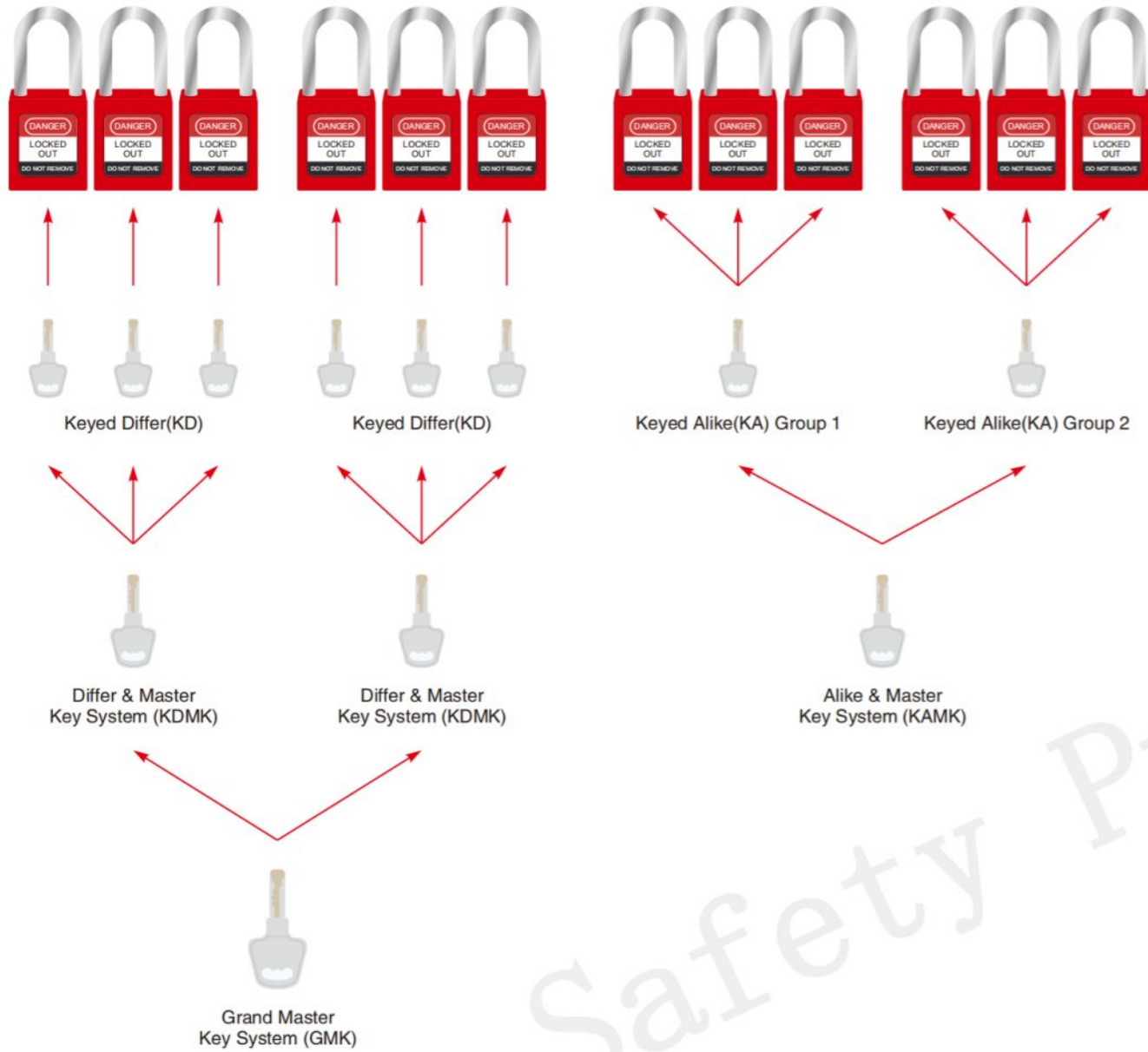

### ● Key Charting System

- Keyed Differ System (KD): Each padlock is keyed differently, supplied with 1 key per lock. 50000pcs individual locks available.
- Keyed Alike System (KA): Each padlock is keyed the same in one group. 1 key will open all padlocks in each group.
- Differ & Master Key System (KDMK): Each padlock is keyed differently, supplied with 1 key per lock. A master key will override and open any of these padlocks.
- Alike & Master Key System (KAMK): Each padlock is keyed the same in one group. A master key will override and open all groups of Alike keyed.
- Grand Master Key System (GMK): Each padlock is keyed different in one group. A grand master key will override and open all different KDMK groups.

### ● Key Charting Registration

It is important that each employee at a site has a unique padlock key to help prevent duplicate keys from jeopardizing your lockout program. We promise to use different key and numbering for each order if required. Besides each key can be recorded in our programming system so that you can reorder the same key whenever necessary.

Eshop: <https://www.lockey.cz/>

### SAFETY PADLOCK SHACKLE LENGTH: 38MM



Part No.	Description	Shackle Material	Specification
KA-P38S	Keyed Alike	Steel	"P": Straight edge plastic lock body "S": Steel shackle "SS": Stainless steel shackle "P": Nylon shackle "A": Aluminum shackle
KD-P38S	Keyed Differ		
MK-P38S	Master & Alike / Differ		
GMK-P38S	Grand Master Key	Stainless Steel	*1key/lock
KA-P38SS	Keyed Alike		
KD-P38SS	Keyed Differ		
MK-P38SS	Master & Alike / Differ	Nylon	*1key/lock
GMK-P38SS	Grand Master Key		
KA-P38P	Keyed Alike		
KD-P38P	Keyed Differ	Nylon	*1key/lock
MK-P38P	Master & Alike / Differ		
GMK-P38P	Grand Master Key		

- Reinforced nylon body, withstand temperature from  $-20^{\circ}\text{C}$  to  $+120^{\circ}\text{C}$ .
- Key Retaining Feature: When the shackle is open, the key can't be removed.
- The steel shackle is chrome plated; the non-conductive shackle is made from nylon, withstand temperature from  $-20^{\circ}\text{C}$  to  $+120^{\circ}\text{C}$ , ensuring the strength and deformation fracture not easily.
- Laser printing and logo engraving available if required.
- All different colors available.

Part No.	Description	Shackle Material	Specification
KA-P76S	Keyed Alike	Steel	"P": Straight edge plastic lock body "S": Steel shackle "SS": Stainless steel shackle "P": Nylon shackle "A": Aluminum shackle "B": Brass shackle
KD-P76S	Keyed Differ		
MK-P76S	Master & Alike / Differ		
GMK-P76S	Grand Master Key	Stainless Steel	*1key/lock
KA-P76SS	Keyed Alike		
KD-P76SS	Keyed Differ		
MK-P76SS	Master & Alike / Differ	Nylon	*1key/lock
GMK-P76SS	Grand Master Key		
KA-P76P	Keyed Alike		
KD-P76P	Keyed Differ	Nylon	*1key/lock
MK-P76P	Master & Alike / Differ		
GMK-P76P	Grand Master Key		



- Reinforced nylon body, withstand temperature from  $-20^{\circ}\text{C}$  to  $+120^{\circ}\text{C}$ .
- Key Retaining Feature: When the shackle is open, the key can't be removed.
- The steel shackle is chrome plated; the non-conductive shackle is made from nylon, withstand temperature from  $-20^{\circ}\text{C}$  to  $+120^{\circ}\text{C}$ , ensuring the strength and deformation fracture not easily.
- Laser printing and logo engraving available if required.
- All different colors available.

### SAFETY PADLOCK SHACKLE LENGTH: 25MM



Part No.	Description	Shackle Material	Specification
KA-P25S	Keyed Alike	Steel	"P": Straight edge plastic lock body "S": Steel shackle "SS": Stainless steel shackle "P": Nylon shackle "A": Aluminum shackle "B": Brass shackle
KD-P25S	Keyed Differ		
MK-P25S	Master & Alike / Differ		
GMK-P25S	Grand Master Key	Nylon	*1key/lock
KA-P25P	Keyed Alike		
KD-P25P	Keyed Differ		
MK-P25P	Master & Alike / Differ		
GMK-P25P	Grand Master Key		

- Reinforced nylon body, withstand temperature from  $-20^{\circ}\text{C}$  to  $+120^{\circ}\text{C}$ .
- Key Retaining Feature: When the shackle is open, the key can't be removed.
- The steel shackle is chrome plated; the non-conductive shackle is made from nylon, withstand temperature from  $-20^{\circ}\text{C}$  to  $+120^{\circ}\text{C}$ , ensuring the strength and deformation fracture not easily.
- Laser printing and logo engraving available if required.
- All different colors available.

Normal color: ● RED, ● YLW, ● BLU, ● DBL, ● GRN, ● ORG, ● PRP, ● BRN, ● BLK, ● WHT, ● GRY  
Other colors can be custom made.

Eshop: <https://www.lockey.cz/>



**MINI SAFETY PADLOCK**  
SHACKLE DIA: 4.2MM



Part No.	Description	Shackle Material	Specification
KA-PS25S	Keyed Alike	Steel	"P": Straight edge plastic lock body "S": Steel shackle "A": Aluminum shackle "B": Brass shackle "SS": Stainless steel shackle *1key/lock
KD-PS25S	Keyed Differ		
MK-PS25S	Master & Alike / Differ		
GMK-PS25S	Grand Master Key	Nylon	
KA-PS25P	Keyed Alike		
KD-PS25P	Keyed Differ		
MK-PS25P	Master & Alike / Differ		
GMK-PS25P	Grand Master Key		

- Reinforced nylon body, withstand temperature from -20°C to +120°C. The non-conductive shackle is made from nylon, withstand temperature from -20°C to +120°C, ensuring the strength and deformation fracture not easily.
- Key Retaining Feature: When the shackle is open, the key can't be removed.
- Laser printing and logo engraving available if required.

Part No.	Description	Shackle Material	Specification
KA-P38SSD4	Keyed Alike	Stainless Steel	"P": Straight edge plastic lock body "A": Aluminum shackle "B": Brass shackle "SS": Stainless steel shackle *1key/lock
KD-P38SSD4	Keyed Differ		
MK-P38SSD4	Master & Alike / Differ		
GMK-P38SSD4	Grand Master Key	Nylon	
KA-P38PD4	Keyed Alike		
KD-P38PD4	Keyed Differ		
MK-P38PD4	Master & Alike / Differ		
GMK-P38PD4	Grand Master Key		
KA-P44SSD4	Keyed Alike	Stainless Steel	
KD-P44SSD4	Keyed Differ		
MK-P44SSD4	Master & Alike / Differ		
GMK-P44SSD4	Grand Master Key		

- Reinforced nylon body, withstand temperature from -20°C to +120°C. Key Retaining Feature: When the shackle is open, the key can't be removed.
- The stainless steel shackle is chrome plated, ensuring the strength and rust protection; the non-conductive shackle is made from nylon, withstand temperature from -20°C to +120°C, ensuring the strength and deformation fracture not easily.
- Laser printing and logo engraving available if required.
- All different colors available.

**SAFETY PADLOCK**  
SHACKLE DIA: 4MM



Part No.	Description	Shackle Material	Specification
KA-P16SSD4	Keyed Alike	Stainless Steel	"P": Straight edge plastic lock body "SS": Stainless steel shackle *1key/lock
KD-P16SSD4	Keyed Differ		
MK-P16SSD4	Master & Alike / Differ		
GMK-P16SSD4	Grand Master Key		
KA-P38SSD4-2	Keyed Alike		
KD-P38SSD4-2	Keyed Differ		
MK-P38SSD4-2	Master & Alike / Differ		
GMK-P38SSD4-2	Grand Master Key		

- Reinforced nylon body, withstand temperature from -20°C to +120°C. The stainless steel shackle is chrome plated, ensuring the strength and rust protection.
- Key Retaining Feature: When the shackle is open, the key can't be removed.
- Laser printing and logo engraving available if required.
- All different colors available.

Normal color: ● RED, ● YLW, ● BLU, ● DBL, ● GRN, ● ORG, ● PRP, ● BRN, ● BLK, ● WHT, ● GRY  
Other colors can be custom made.

Eshop: <https://www.lockey.cz/>

**DUSTPROOF SAFETY PADLOCK**



Part No.	Description	Shackle Material	Specification
KA-P38SDP	Keyed Alike	Steel	"P": Straight edge plastic lock body "S": Steel shackle "A": Aluminum shackle "B": Brass shackle "SS": Stainless steel shackle *1key/lock
KD-P38SDP	Keyed Differ		
MK-P38SDP	Master & Alike / Differ		
GMK-P38SDP	Grand Master Key	Nylon	
KA-P38PDP	Keyed Alike		
KD-P38PDP	Keyed Differ		
MK-P38PDP	Master & Alike / Differ		
GMK-P38PDP	Grand Master Key		

- Reinforced nylon body, withstand temperature from -20°C to +120°C. Key Retaining Feature: When the shackle is open, the key can't be removed.
- The steel shackle is chrome plated; the non-conductive shackle is made from nylon, withstand temperature from -20°C to +120°C, ensuring the strength and deformation fracture not easily.
- Shackle Length: 25mm, 38mm, 76mm.
- Laser printing and logo engraving available if required.
- All different colors available.

Part No.	Description	Shackle Material	Specification
KA-P38SR1	Keyed Alike	Steel	"P": Straight edge plastic lock body "S": Steel shackle "A": Aluminum shackle "B": Brass shackle "SS": Stainless steel shackle *1key/lock
KD-P38SR1	Keyed Differ		
MK-P38SR1	Master & Alike / Differ		
GMK-P38SR1	Grand Master Key	Nylon	
KA-P38PR1	Keyed Alike		
KD-P38PR1	Keyed Differ		
MK-P38PR1	Master & Alike / Differ		
GMK-P38PR1	Grand Master Key		
R1	Silica cover only		

**DUSTPROOF SILICA COVERED SAFETY PADLOCK**



- Reinforced nylon body, withstand temperature from -20°C to +120°C. Key Retaining Feature: When the shackle is open, the key can't be removed.
- The steel shackle is chrome plated; the non-conductive shackle is made from nylon, withstand temperature from -20°C to +120°C, ensuring the strength and deformation fracture not easily.
- The cover is made of non-transparent silicone.
- Laser printing and logo engraving available if required.
- Different types of lock bodies and all different colors available.

**DUSTPROOF SILICA COVERED SAFETY PADLOCK**



Part No.	Description	Shackle Material	Specification
KA-P38SR2	Keyed Alike	Steel	"P": Straight edge plastic lock body "S": Steel shackle "A": Aluminum shackle "B": Brass shackle "SS": Stainless steel shackle *1key/lock
KD-P38SR2	Keyed Differ		
MK-P38SR2	Master & Alike / Differ		
GMK-P38SR2	Grand Master Key	Nylon	
KA-P38PR2	Keyed Alike		
KD-P38PR2	Keyed Differ		
MK-P38PR2	Master & Alike / Differ		
GMK-P38PR2	Grand Master Key		
R2	Silica cover only		

- Reinforced nylon body, withstand temperature from -20°C to +120°C. Key Retaining Feature: When the shackle is open, the key can't be removed.
- The steel shackle is chrome plated; the non-conductive shackle is made from nylon, withstand temperature from -20°C to +120°C, ensuring the strength and deformation fracture not easily.
- The cover is made of translucent silicone.
- Laser printing and logo engraving available if required.
- Different types of lock bodies and all different colors available.

Normal color: ● RED, ● YLW, ● BLU, ● DBL, ● GRN, ● ORG, ● PRP, ● BRN, ● BLK, ● WHT, ● GRY  
Other colors can be custom made.

Eshop: <https://www.lockey.cz/>



### SAFETY PADLOCK CABLE SHACKLE

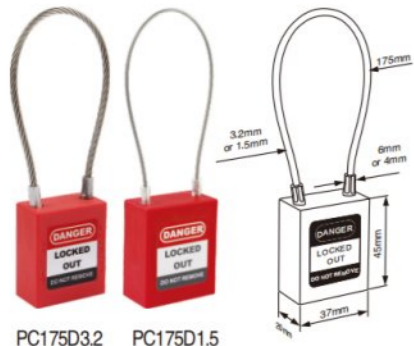

PC175D3.2 PC175D1.5

Part No.	Description	Shackle Material	Specification
KA-PC175D3.2	Keyed Alike	Stainless Steel Cable	"P": Straight edge plastic lock body *1key/lock
KD-PC175D3.2	Keyed Differ		
MK-PC175D3.2	Master & Alike / Differ		
GMK-PC175D3.2	Grand Master Key	Stainless Steel Cable	
KA-PC175D1.5	Keyed Alike		
KD-PC175D1.5	Keyed Differ		
MK-PC175D1.5	Master & Alike / Differ		
GMK-PC175D1.5	Grand Master Key		

- Reinforced nylon body, withstand temperature from  $-20^{\circ}\text{C}$  to  $+120^{\circ}\text{C}$ . The cable shackle is made from stainless steel, ensuring the strength and can't be deformed easily.
- Key Retaining Feature: When the shackle is open, the key can't be removed.
- Other cable lengths can be customized.
- Laser printing and logo engraving available if required.

Part No.	Description	Shackle Material	Specification
KA-CP25SPU	Keyed Alike	Steel	"CP": Lockey patented design lock body
KD-CP25SPU	Keyed Differ		"S": Steel shackle
MK-CP25SPU	Keyed & Alike / Differ		"A": Aluminum shackle
GMK-CP25SPU	Grand Master Key		"B": Brass shackle
KA-CP25PPU	Keyed Alike	Nylon	"SS": Stainless steel shackle
KD-CP25PPU	Keyed Differ		Other body shapes (P, AP, BP) also available.
MK-CP25PPU	Keyed & Alike / Differ		*1key/lock
GMK-CP25PPU	Grand Master Key		

### POP-UP SAFETY PADLOCK DIA. 6MM, LENGTH 25MM



CP25SPU CP25PPU

- Reinforced nylon body, withstand temperature from  $-20^{\circ}\text{C}$  to  $+120^{\circ}\text{C}$ . The steel shackle is chrome plated; the non-conductive shackle is made from nylon, withstand temperature from  $-20^{\circ}\text{C}$  to  $+120^{\circ}\text{C}$ , ensuring the strength and deformation fracture not easily.
- Durable brass cylinder, high strength, wear-resistant, anti-rust.
- Pop-Up Feature: The shackle will pop up automatically when unlocking. Press the shackle when locking, no key is needed to insert and pull out.
- Laser printing and logo engraving available if required.
- All different colors available.

### POP-UP SAFETY PADLOCK DIA.6MM, LENGTH 38MM



CP38SPU CP38PPU

Part No.	Description	Shackle Material	Specification
KA-CP38SPU	Keyed Alike	Steel	"CP": Lockey patented design lock body
KD-CP38SPU	Keyed Differ		"S": Steel shackle
MK-CP38SPU	Keyed & Alike / Differ		"A": Aluminum shackle
GMK-CP38SPU	Grand Master Key		"B": Brass shackle
KA-CP38PPU	Keyed Alike	Nylon	"SS": Stainless steel shackle
KD-CP38PPU	Keyed Differ		Other body shapes (P, AP, BP) also available.
MK-CP38PPU	Keyed & Alike / Differ		*1key/lock
GMK-CP38PPU	Grand Master Key		

- Reinforced nylon body, withstand temperature from  $-20^{\circ}\text{C}$  to  $+120^{\circ}\text{C}$ . The steel shackle is chrome plated; the non-conductive shackle is made from nylon, withstand temperature from  $-20^{\circ}\text{C}$  to  $+120^{\circ}\text{C}$ , ensuring the strength and deformation fracture not easily.
- Durable brass cylinder, high strength, wear-resistant, anti-rust.
- Pop-Up Feature: The shackle will pop up automatically when unlocking. Press the shackle when locking, no key is needed to insert and pull out.
- Laser printing and logo engraving available if required.
- All different colors available.

Normal color: ● RED, ● YLW, ● BLU, ● DBL, ● GRN, ● ORG, ● PRP, ● BRN, ● BLK, ● WHT, ● GRY  
Other colors can be custom made.

Eshop: <https://www.lockey.cz/>

### POP-UP SAFETY PADLOCK DIA. 6MM, LENGTH 76MM

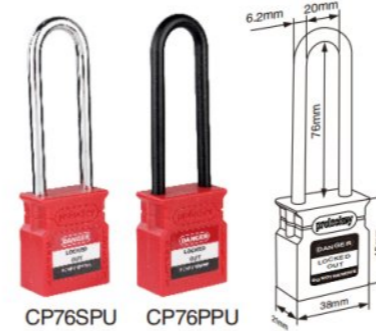

CP76SPU CP76PPU

Part No.	Description	Shackle Material	Specification
KA-CP76SPU	Keyed Alike	Steel	"CP": Lockey patented design lock body
KD-CP76SPU	Keyed Differ		"S": Steel shackle
MK-CP76SPU	Keyed & Alike / Differ		"A": Aluminum shackle
GMK-CP76SPU	Grand Master Key		"B": Brass shackle
KA-CP76PPU	Keyed Alike	Nylon	"SS": Stainless steel shackle
KD-CP76PPU	Keyed Differ		Other body shapes (P, AP, BP) also available.
MK-CP76PPU	Keyed & Alike / Differ		*1key/lock
GMK-CP76PPU	Grand Master Key		

- Reinforced nylon body, withstand temperature from  $-20^{\circ}\text{C}$  to  $+120^{\circ}\text{C}$ . The steel shackle is chrome plated; the non-conductive shackle is made from nylon, withstand temperature from  $-20^{\circ}\text{C}$  to  $+120^{\circ}\text{C}$ , ensuring the strength and deformation fracture not easily.
- Durable brass cylinder, high strength, wear-resistant, anti-rust.
- Pop-Up Feature: The shackle will pop up automatically when unlocking. Press the shackle when locking, no key is needed to insert and pull out.
- Laser printing and logo engraving available if required.
- All different colors available.

Part No.	Description	Shackle Material	Specification
KA-CP38SSD4PU	Keyed Alike	Stainless Steel	"CP": Lockey patented design lock body
KD-CP38SSD4PU	Keyed Differ		"SS": Stainless steel shackle
MK-CP38SSD4PU	Master & Alike / Differ		*1key/lock
GMK-CP38SSD4PU	Grand Master Key		

- Reinforced nylon body, withstand temperature from  $-20^{\circ}\text{C}$  to  $+120^{\circ}\text{C}$ . The stainless steel shackle is chrome plated, ensuring the strength and rust protection; the non-conductive shackle is made from nylon, withstand temperature from  $-20^{\circ}\text{C}$  to  $+120^{\circ}\text{C}$ , ensuring the strength and deformation fracture not easily.
- Durable brass cylinder, high strength, wear-resistant, anti-rust.
- Pop-Up Feature: The shackle will pop up automatically when unlocking. Press the shackle when locking, no key is needed to insert and pull out.
- Laser printing and logo engraving available if required.
- All different colors available.

### POP-UP SAFETY PADLOCK SHACKLE DIA: 4MM



CP38SSD4PU

### POP-UP SAFETY PADLOCK SHACKLE DIA: 4MM



CP16SSD4PU CP38SSD4PU-2

Part No.	Description	Shackle Material	Specification
KA-CP16SSD4PU	Keyed Alike	Stainless Steel	"CP": Lockey patented design lock body
KD-CP16SSD4PU	Keyed Differ		"SS": Stainless steel shackle
MK-CP16SSD4PU	Master & Alike / Differ		Other body shapes (P, AP, BP) also available.
GMK-CP16SSD4PU	Grand Master Key		*1key/lock
KA-CP38SSD4PU-2	Keyed Alike	Stainless Steel	
KD-CP38SSD4PU-2	Keyed Differ		
MK-CP38SSD4PU-2	Master & Alike / Differ		
GMK-CP38SSD4PU-2	Grand Master Key		

- Reinforced nylon body, withstand temperature from  $-20^{\circ}\text{C}$  to  $+120^{\circ}\text{C}$ . The stainless steel shackle is chrome plated, ensuring the strength and rust protection.
- Durable brass cylinder, high strength, wear-resistant, anti-rust.
- Pop-Up Feature: The shackle will pop up automatically when unlocking. Press the shackle when locking, no key is needed to insert and pull out.
- Laser printing and logo engraving available if required.
- All different colors available.

Normal color: ● RED, ● YLW, ● BLU, ● DBL, ● GRN, ● ORG, ● PRP, ● BRN, ● BLK, ● WHT, ● GRY  
Other colors can be custom made.

Eshop: <https://www.lockey.cz/>



SAFETY PADLOCK



WCP38S

Part No.	Shackle Material	A(mm)	B(mm)	C(mm)	Specification
WCP25S	Steel	41	45	25	Support keyed alike, keyed differ, master keyed and grand master keyed system. *1key/lock
WCP38S		41	45	38	
WCP76S		41	45	76	
WCP25P	Nylon	41	45	25	
WCP38P		41	45	38	
WCP76P		41	45	76	

- Made of copper cylinder and key. More resistant to corrosion and rust. Very stable, with more than 1 million times operating.
- Reinforced nylon body, withstand temperature from -20°C to +120°C. The steel shackle is chrome plated; the non-conductive shackle is made from nylon, withstand temperature from -20°C to +120°C, ensuring the strength and deformation fracture not easily.
- Key Retaining Feature: When the shackle is open, the key can't be removed.
- Laser printing and logo engraving available if required.
- All different colors available.

Part No.	Shackle Material	A(mm)	B(mm)	C(mm)	Specification
WBP25S	Steel	41	45	25	Support keyed alike, keyed differ, master keyed and grand master keyed system. *1key/lock
WBP38S		41	45	38	
WBP76S		41	45	76	
WBP25P	Nylon	41	45	25	
WBP38P		41	45	38	
WBP76P		41	45	76	

SAFETY PADLOCK



WBP38S

- Made of copper cylinder and key. More resistant to corrosion and rust. Very stable, with more than 1 million times operating.
- Reinforced nylon body, withstand temperature from -20°C to +120°C. The steel shackle is chrome plated; the non-conductive shackle is made from nylon, withstand temperature from -20°C to +120°C, ensuring the strength and deformation fracture not easily.
- Key Retaining Feature: When the shackle is open, the key can't be removed.
- Laser printing and logo engraving available if required.
- All different colors available.

SAFETY PADLOCK



WDP40SD5 WDP40SR3

Part No.	Shackle Material	A(mm)	B(mm)	C(mm)	Specification
WDP40SD5	Steel	5	40	22	Support keyed alike, keyed differ, master keyed and grand master keyed system. *1key/lock
WDP40SR3	Steel with plastic coat	6.2	40	19	

- Made of copper cylinder&key with nylon body. More Resistant...
- Reinforced nylon body, withstand temperature from -20°C to +120°C. The steel shackle is chrome plated; the non-conductive shackle is made from nylon, withstand temperature from -20°C to +120°C, ensuring the strength and deformation fracture not easily.
- Key Retaining Feature: When the shackle is open, the key can't be removed.
- Laser printing and logo engraving available if required.
- All different colors available.

Normal color: ● RED, ● YLW, ● BLU, ● DBL, ● GRN, ● ORG, ● PRP, ● BRN, ● BLK, ● WHT, ● GRY  
Other colors can be custom made.

Eshop: <https://www.lockey.cz/>

SAFETY PADLOCK WITH LONG BODY



CPL38S

CPL38P

Part No.	Shackle Material	A(mm)	B(mm)	C(mm)	Specification
CPL25S	Steel	37	75	25	Support keyed alike, keyed differ, master keyed and grand master keyed system. *1key/lock
CPL38S		37	75	38	
CPL76S		37	75	76	
CPL25P	Nylon	37	75	25	
CPL38P		37	75	38	
CPL76P		37	75	76	

- Reinforced nylon body, withstand temperature from -20°C to +120°C. The steel shackle is chrome plated; the non-conductive shackle is made from nylon, withstand temperature from -20°C to +120°C, ensuring the strength and deformation fracture not easily.
- Key Retaining Feature: When the shackle is open, the key can't be removed.
- Laser printing and logo engraving available if required.
- All different colors available.

Economic Safety Padlock SHACKLE LENGTH: 25MM/38MM/76MM



UP25S

UP38P

UP76S

Part No.	Shackle Material	A(mm)	B(mm)	C(mm)	Specification
UP25S	Steel	39	45	25	keyed differ, keyed alike, master keyed and grand master keyed supported.
UP38S		39	45	38	
UP76S		39	45	76	
UP25P	Nylon	39	45	25	
UP38P		39	45	38	
UP76P		39	45	76	

- Industrial ABS body with nylon shackle, withstand temperature from -20°C to +90°C. The steel shackle is chrome plated; the non-conductive shackle is made from nylon, withstand temperature from -20°C to +120°C, ensuring the strength and deformation fracture not easily.
- Key Retaining Feature: When the shackle is open, the key can't be removed.
- Laser printing and logo engraving available if required.

Part No.	Specification	Description
ALP25S	Inner shackle:25mm; diameter:6mm	Support keyed differ, keyed alike, master keyed, and grand master keyed system.
ALP38S	Inner shackle:38mm; diameter:6mm	
ALP76S	Inner shackle:76mm; diameter:6mm	

- Aluminum body and triple-coated hardened chrome plated steel shackle.
- When unlocking the padlock, the shackle will pop up automatically.
- Shackle Length: 25mm, 38mm, 76mm.
- Normal color: RED, YLW, BLU, ORG, GRN, PRP, BLK, SLV.
- Other shackle lengths can be customized.



ALP25S

ALP38S

ALP76S

Eshop: <https://www.lockey.cz/>



**BRASS PADLOCK WITH STEEL SHACKLE**

Part No.	Description	A(mm)	B(mm)	C(mm)	D(mm)
BRP25S	KA, KD	22	6	32.6	39.6
BRP60S		63	6	32.6	39.6

- Solid brass body and hardened chrome plated steel shackle, strong corrosion resistance.
- With durable brass cylinder, anti-cutting and anti-sawing. Each padlock is equipped with 2 keys.
- Lock body size: 30mm, 40mm, 50mm, 60mm, 70mm. Other sizes can be customized.
- Other shackle lengths can be customized.

Part No.	Description	A(mm)	B(mm)	C(mm)	D(mm)
LP01	KA, KD	23	6	35	40
LP02		38	6	35	40
LP05		63	6	35	40

- Made from hardened steel with more durable brass cylinder, anti-cutting and anti-sawing.
- With a plastic cover in the bottom, normally in blue. Other colors available.
- Keyed different, Keyed alike available.
- Other lock width and shackle length also available.

**LAMINATED SAFETY PADLOCK****LAMINATED SAFETY PADLOCK**

Part No.	Description	A(mm)	B(mm)	C(mm)	D(mm)
LPC01	KA, KD	27	7.3	41	48
LPC02		42	7.3	41	48

- Shackle made from hardened steel with PVC cover, anti-cutting and anti-sawing.
- Durable brass cylinder, high strength, high accuracy, anti-rust.
- A cap to cover the key hole, water proof and dust proof.
- Different colors and shackles available.

**VALVE LOCKOUT**

Lock out, stay safe.



### ADJUSTABLE BALL VALVE LOCKOUT

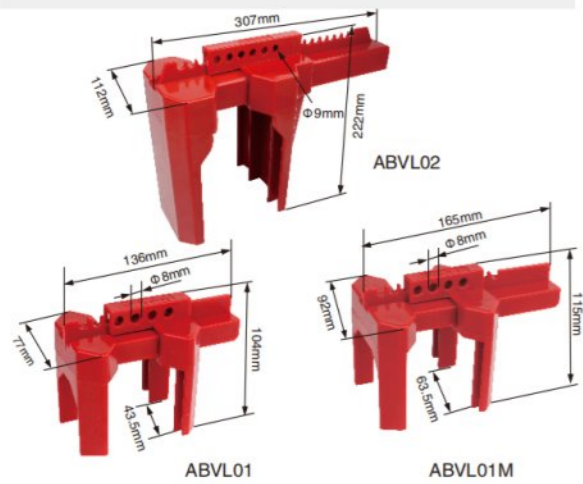

Part No.	Description
ABVL01	Suitable for pipes 1/2" to 2.5" in diameter, OPEN on pipes from 1/2" to 1.25"
ABVL01M	Suitable for pipes 1/2" to 3.15" in diameter, OPEN on pipes from 1/2" to 2.5"
ABVL02	Suitable for pipes 2" to 8" in diameter

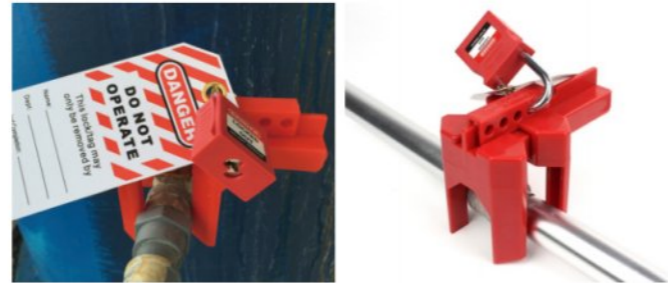

- Made from durable ABS, withstand temperature from -20°C to +90°C, highly resistant of cracking and abrasion and supports extreme weather temperature conditions.
- The two halves of the lockout encompass the ball valve handle to secure it from inadvertent activation of the valve handle.

Part No.	Description
ABVL03	Suitable for pipes diameter from 9.5mm (3/8") to 31mm (1 1/5")
ABVL03F	Suitable for pipes diameter from 9.5mm (3/8") to 31mm (1 1/5"), with front and back foot board
ABVL04	Suitable for pipes diameter from 13mm (1/2") to 70mm (2 3/4")
ABVL04F	Suitable for pipes diameter from 13mm (1/2") to 70mm (2 3/4"), with front and back foot board
ABVL05	Suitable for pipes diameter from 73mm (2 4/5") to 215mm (8 1/2")

### ADJUSTABLE BALL VALVE LOCKOUT



- Made from ABS, withstand temperature from -20°C to +90°C.
- Removable insert accommodates a wide range of handle designs and dimensions.
- It has an auxiliary rear plate, which can lock out double roll valves.

### UNIVERSAL BALL VALVE LOCKOUT

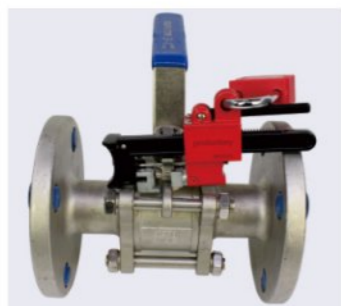
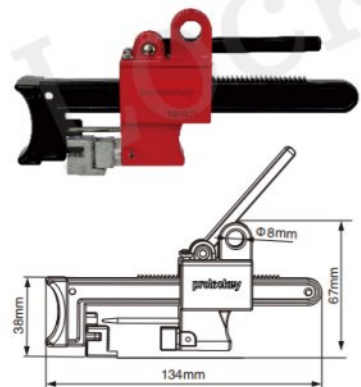

Part No.	Description
UBVL01	Suitable for valve diameters 6mm(1/4") to 101mm(4") and works on insulated pipes and in close quarters

- Made from zinc alloy, surface treatment by high temperature spraying, rust proof.
- Designed to lock out different types of ball valve, clamp tight on handle stop to prevent handle movement.
- Device encloses the valve stem, with the handle removed, to make accidental reactivation virtually impossible.
- Accept up to 1 padlock, locking shackle max diameter 8mm.
- Can be equipped together with hasps for multiple lockout usage.

### HANDLE-OFF BALL VALVE LOCKOUT



Part No.	Description
UBVL21	Universal fit-effectively locks out all valves from 3/8in (10mm) to 4in (102mm)



- Made from PC, PU and PVC.
- Easy to carry and operate, use the belt to fix the lockout bag.
- Fine tailoring, smooth surface, excellent workmanship.
- Fits virtually all types of pipe including insulated, PVC and metal.
- Most 4pcs padlocks can lock on at the same time. Suitable for multiple people or work groups.

Part No.	Description
SBVL01	Size: 84mm x 60mm, hole diameter: 9.8mm
SBVL02	Size: 155mm x 110mm, hole diameter: 9.8mm
SBVL02-2	Size: 155mm x 110mm, hole diameter: 7.5mm

### STANDARD BALL VALVE LOCKOUT

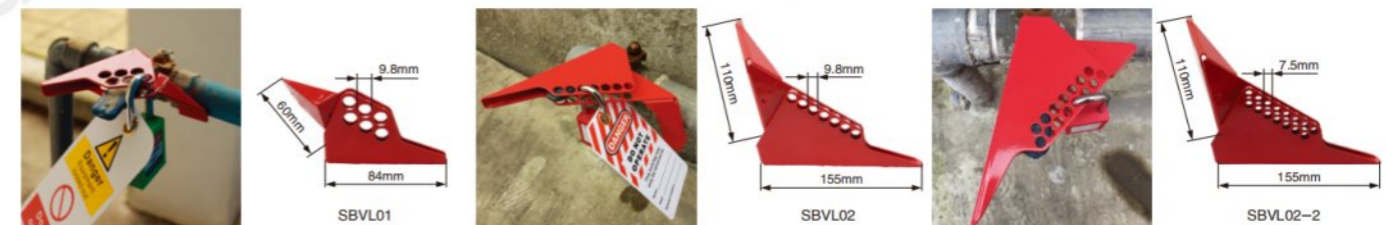

- Made from hardened steel, surface treatment by high temperature spraying, rust proof.
- The single-piece design locks can quarter-turn ball valves in off position.
- Used on ball valve sizes from 6.35mm (1/4") to 25mm (1"), hole diameter is 3/8".

### ADJUSTABLE FLANGED BALL VALVE LOCKOUT

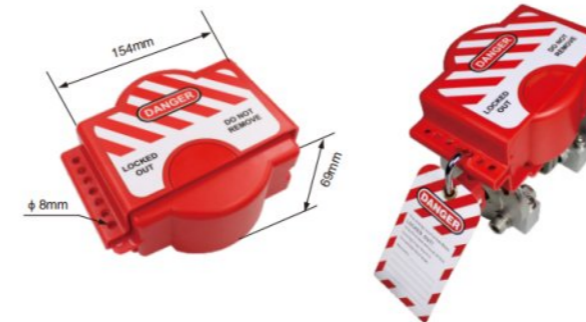

Part No.	Description
FBVL01	Suitable for 6.35mm(1/4") to 140mm(5") flanged ball valves

- Made from durable ABS, withstand temperature from -20°C to +90°C.
- Accept up to 1 padlock, locking shackle max diameter 8mm.
- Available in red color, other colors can be customized, providing English tags.



### STANDARD GATE VALVE LOCKOUT



Part No.	Description	A	B	C
SGVL11	Suitable for valve handle 1" to 2 1/2" in diameter	83	28	19
SGVL12	Suitable for valve handle 2 1/2" to 5" in diameter	136	38	39
SGVL13	Suitable for valve handle 5" to 6 1/2" in diameter	170	50	64
SGVL14	Suitable for valve handle 6 1/2" to 10" in diameter	260	59	85
SGVL15	Suitable for valve handle 10" to 13" in diameter	360	76	99
SGVL16	Suitable for valve handle 13" to 18" in diameter	460	78	95
SGVL17	Suitable for valve handle 18" to 25" in diameter	655	63	135

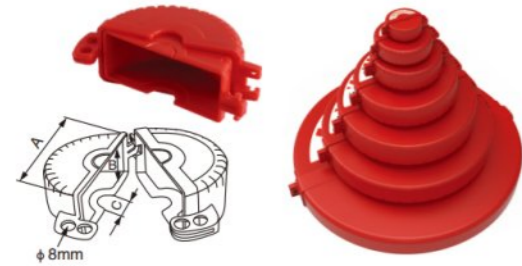

- Made from durable ABS, withstand temperature from -20°C to +90°C, metal free.
- Once locked, it covers wholly around the hand wheel and prevent the valve wheel from being turned.
- Two parts design can be combined into one when storing and carrying which reduce the half restore space.
- Accept up to 2 padlocks, locking shackle max diameter 8mm.
- Available in 7 sizes and red color, other colors can be customized, providing English tag.

Part No.	Description	A	B	C
SGVL01	Suitable for valve handle 1" to 2 1/2" in diameter	80	30	20
SGVL01-H40	Suitable for valve handle 1" to 2 1/2" in diameter	80	30	40
SGVL02	Suitable for valve handle 2 1/2" to 5" in diameter	142	37	45
SGVL03	Suitable for valve handle 5" to 6 1/2" in diameter	184	44	63
SGVL04	Suitable for valve handle 6 1/2" to 10" in diameter	280	67	89
SGVL05	Suitable for valve handle 10" to 13" in diameter	364	67	105

### STANDARD GATE VALVE LOCKOUT



- Made from durable ABS, withstand temperature from -20°C to +90°C.
- Once locked, it covers around the hand wheel and prevent the valve wheel from being turned.
- Accept up to 1 padlock, locking shackle max diameter 9.8mm.
- Available in 5 sizes and red color, other colors can be customized, providing English tag.
- Transparent one can be customized with PC.
- Part no.: SGVL01-TR ~ SGVL05-TR.



### ADJUSTABLE GATE VALVE LOCKOUT



Part No.	Description
AGVL01	Suitable for valve handle 1" to 6 1/2" in diameter

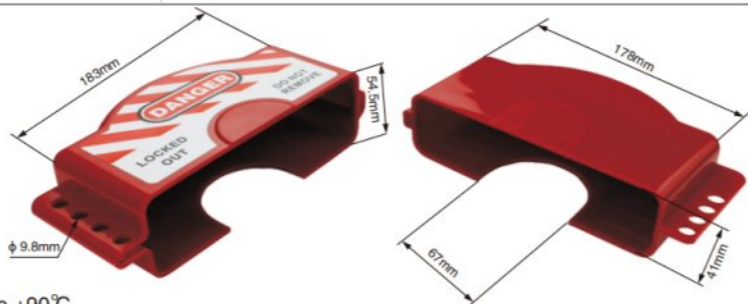

- Made from durable ABS, withstand temperature from -20°C to +90°C.
- Can be equipped together with padlocks. Padlock locking shackle max diameter 3/8"(9.8mm).
- Can be covered and rotated freely around valve wheel, and adjustable to fit a range of valve handles.

Eshop: <https://www.lockey.cz/>

### BUTTERFLY VALVE LOCKOUT

Part No.	Description
BVL01	Suitable for valve handle from 8mm to 45mm



- Made from ABS, withstand temperature from -20°C to +90°C.
- Good chemical property, resistant to oil stains and chemical product corrosion.
- Can be covered and rotated freely around valve wheels and adjustable to fit all ranges of valve handles.

Part No.	Description	ADJUSTABLE BUTTERFLY VALVE LOCKOUT
BVL11	Adjustable angle :15° ~36°	

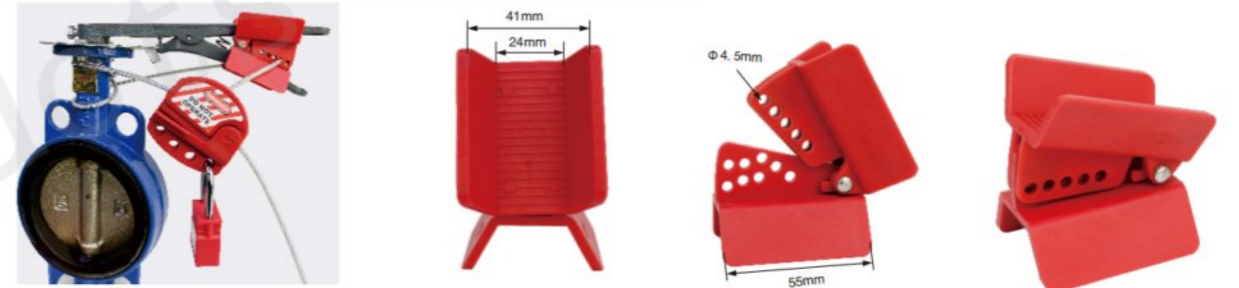

- Locks out valve in seconds by feeding CB01 cable lockout device through desired eyelet and around valve neck.
- Made from nylon PA.Durable, lightweight thermoplastic material is chemical resistant and performs effectively in extreme environments.
- Directional application arrows allow for ease of installation and minimize user error.
- Stainless steel rivet allows device to smoothly pivot open and closed to ensure proper fit.

### BUTTERFLY VALVE LOCKOUT

Part No.	Description
BVL31	Hole diameter: 8mm

- Made of durable ABS plastic.
- Exclusive, anti-pivot lockout device fits the full range of pull handle valve sizes, from 1/2 in. to 8 in. diameter.
- A convenient, one-piece design that stays together whether in use or in storage.
- Holds up to three worker padlocks.
- Effective for all popular pull handle valves commonly used in food and beverage, water utilities, chemical, pharmaceutical and many other industries.
- Secures the valve handle in any desired position, from fully closed, to partially or fully open.

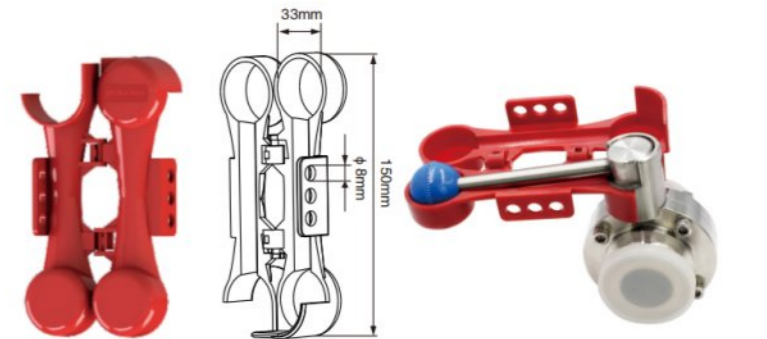

Eshop: <https://www.lockey.cz/>



Part No.	Description
BVL41-1	Suitable for butterfly valve
BVL41-2	Suitable for T shape ball valve

- Made from PA, withstand temperature from  $-20^{\circ}\text{C}$  to  $+120^{\circ}\text{C}$ .
- The metal part is made of stainless steel, corrosion resistant.
- Used for butterfly valve and T shape ball valve that need to be locked in food, chemical, pharmaceutical area.

## VALVE LOCKOUT



BVL41-1

BVL41-2

## ADJUSTABLE SANITARY BUTTERFLY VALVE LOCKOUT

Part No.	Description
BVL51-D35	Suitable for sanitary butterfly valve with 35mm diameter head

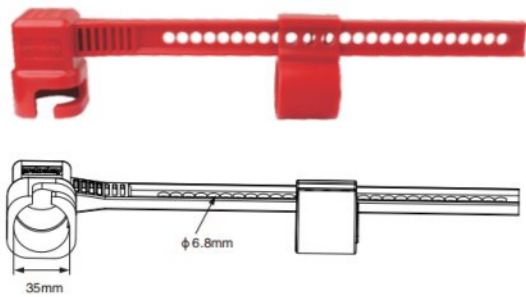

- Made of ABS engineering plastic, Temperature resistance  $-20^{\circ}\text{C}$  to  $+90^{\circ}\text{C}$ .
- Freely adjustable, fits most of the current market sanitary butterfly valve lock handle length.
- Suitable for food, pharmaceutical and other situations.
- Can be managed by one people.

## BLIND FLANGE LOCKOUT

Part No.	Description
BFL01	Suitable for 3/4in to 1-1/8in (19mm - 28.7mm) nut diameters, Suitable for handwheel size 0.5 "-3" (12.7-76.2mm) flanged valves
BFL02	Suitable for 1-5/16in to 1-7/8in (33.3mm - 47.8mm) nut diameters, Suitable for handwheel size 3 "-14" (76.2-355.6mm) flanged valves
BFL03	Suitable for 2in to 2-3/4in (52.3mm - 69.9mm) nut diameters, Suitable for handwheel size 14 "-48" (355.6-1219.2mm) flanged valves



- Made from strong and durable aluminum alloy, can withstand a variety of harsh indoor and outdoor environments.
- Hidden flange nut when locked, prevent misuse.
- Adjustable size, adaptable to a wide range of flanged pipes.
- Accepts up to 4 management holes for locking.

Part No.	Description
UVL01S	Small lockout for handle width up to 15mm, with 1 arm
UVL01	Handle width up to 28mm, with 1 arm—For quarter—turn ball valves
UVL01P	Large lockout for handle width up to 45mm, with 1 arm
UVL02S	Small lockout for handle width up to 15mm, with 2 arms
UVL02	Handle width up to 28mm, with 2 arms—For 3,4 or 5—way valves, or to lock valves in the "on", "off" or "throttled" position
UVL02P	Large lockout for handle width up to 45mm, with 2 arms
UVL03S	Small lockout for handle width up to 15mm, with coated cable
UVL03	Handle width up to 28mm, with coated cable—For gate valves
UVL03P	Large lockout for handle width up to 45mm, with coated cable
UVL05S	Small lockout for handle width up to 15mm, with 1 arm & coated cable
UVL05	Handle width up to 28mm, with 1 arm & coated cable—Universal valve lockout for most valves
UVL05P	Large lockout for handle width up to 45mm, with 1 arm & coated cable

## UNIVERSAL GATE VALVE LOCKOUT

- Made from industrial grade steel and nylon, withstand temperature from  $-20^{\circ}\text{C}$  to  $+120^{\circ}\text{C}$ .
- Enables to lock out valves of different types and sizes, such as large levers of valves, T—handles and other hard—to—secure mechanical devices.
- No other device offers such flexibility and security.
- Designed to handle extra impact and resist chemicals making them ideal for just about any environment.

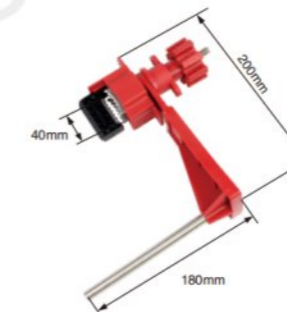

UVL01



UVL02



UVL03



UVL04



UVL05



## BUTTERFLY VALVE LOCKOUT

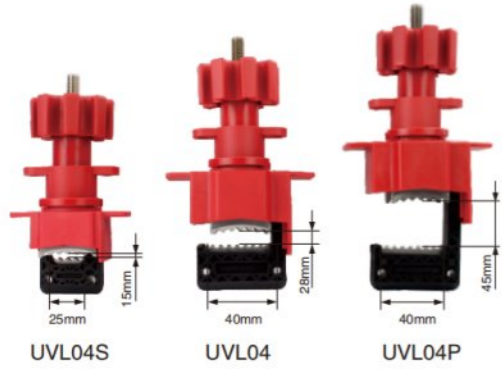

Part No.	Description
UVL04S	Max handle width 15mm
UVL04	Max handle width 28mm
UVL04P	Max handle width 45mm

- Made from industrial grade steel and nylon, withstand temperature from  $-20^{\circ}\text{C}$  to  $+120^{\circ}\text{C}$ .
- Enable to lock out different types of butterfly valve with the base clamp.
- No other device offers such flexibility and security.
- Designed to handle extra impact and resist chemicals making them ideal for just about any environment.
- Can be matched with different fittings to make a series of universal valves.

## BLOCKING ARM

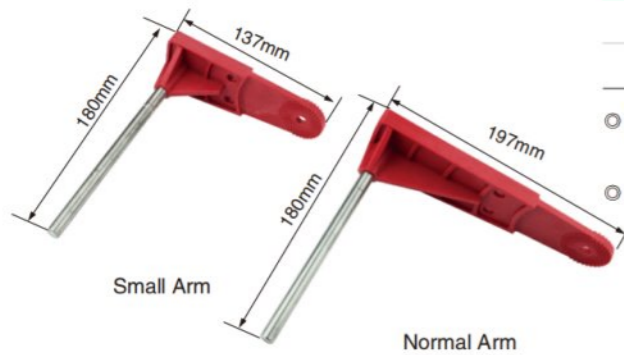

Part No.	Description
Small Arm	Size: 180mm(L)
Normal Arm	Size: 180mm(L)

- Made from industrial grade steel and nylon, withstand temperature from  $-20^{\circ}\text{C}$  to  $+120^{\circ}\text{C}$ .
- Used with universal valve lockout base.

Part No.	Description
VSBL03-2	Hole diameter: 32mm, 46mm
VSBL03-3	Hole diameter: 24.4mm



- Made of transparent PC, withstand temperature from  $-20^{\circ}\text{C}$  to  $+120^{\circ}\text{C}$ .
- Once locked, prevent the valve from being turned.
- The base allows use with two semicircles to accommodate valve.
- Accommodates valve up to 55mm diameter and 43mm tall.
- Fits 24.4mm and 32mm-46mm diameter valve.

## DIAPHRAGM VALVE LOCKOUT

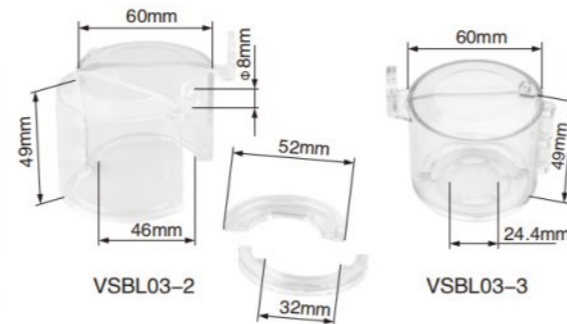

## VALVE LOCKOUT

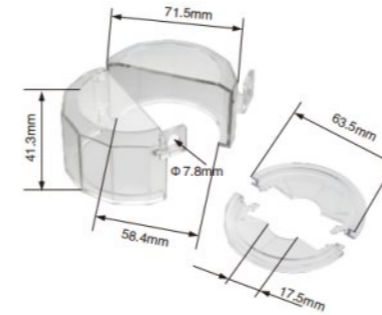

- Made of transparent PC, withstand temperature from  $-20^{\circ}\text{C}$  to  $+120^{\circ}\text{C}$ .
- Prevent the valve handles from being turned when locked out.
- Using the two semicircles to accommodate double lock valves.
- Accommodates buttons up to 41mm tall.

## VALVE LOCKOUT

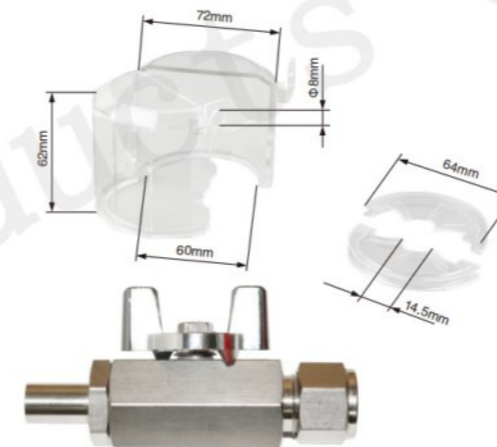

Part No.	Description
VSBL04	Hole diameter: 8mm



- Made of transparent PC, withstand temperature from  $-20^{\circ}\text{C}$  to  $+120^{\circ}\text{C}$ .
- Prevent the valve handles from being turned when locked out.
- Using the two semicircles to accommodate double lock valves.
- Accommodates buttons up to 60mm tall.

## DIAPHRAGM VALVE LOCKOUT

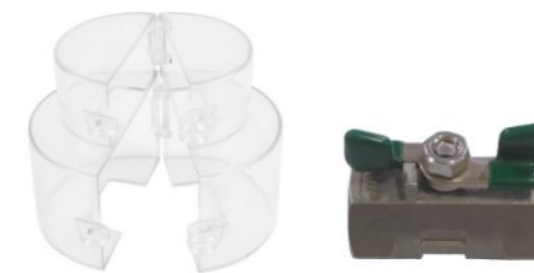

Part No.	Description
VSBL11	Hole diameter: 31.9mm x 31.9mm
VSBL12	Hole diameter: 40mm x 40mm

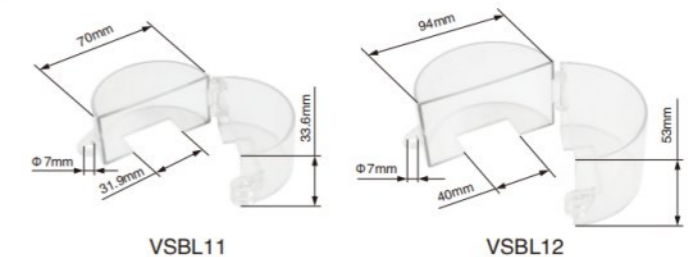

- Made of transparent PC, withstand temperature from  $-20^{\circ}\text{C}$  to  $+120^{\circ}\text{C}$ .
- Prevent the valve handles from being turned when locked out.
- Buckle directly to lock.
- VSBL11 can accommodate inner valve up to 65mm diameter and 29mm tall. VSBL12 can accommodate inner valve up to 89mm diameter and 49mm tall.
- VSBL11 can accommodate outer valve up to 70mm diameter and 33.6mm tall. VSBL12 can accommodate outer valve up to 94mm diameter and 53mm tall.



Part No.	(A)Hole diameter
VSBL21-2	32mm
VSBL21-3	24.5mm

## DIAPHRAGM VALVE LOCKOUT

- Made of transparent PC, withstand temperature from  $-20^{\circ}\text{C}$  to  $+120^{\circ}\text{C}$ .
- Once locked, prevent the valve from being turned.
- The base allows use with two semicircles to accommodate valve.
- Fits 24.5mm and 32mm–46mm diameter valve.

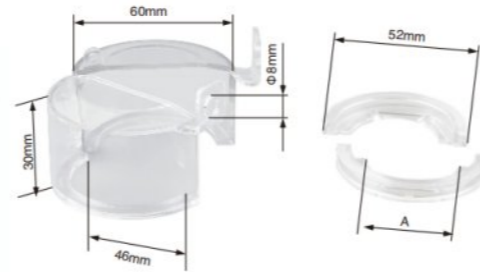

## CABLE LOCKOUT

Lock out, stay safe.



## ADJUSTABLE STEEL CABLE LOCKOUT

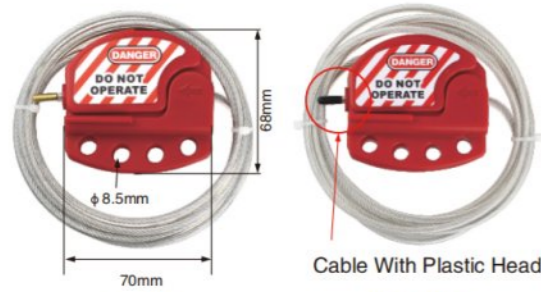

- Lock body: made of ABS, withstands chemicals.
- Cable: tough, flexible multi-stranded steel cable, with clear plastic insulation coating.
- Cable length can be customized.
- Accepts up to 4 padlocks for multiple lockout application.

Part No.	Description
CB01-4	Cable diameter 4mm, length 2m
CB01-6	Cable diameter 6mm, length 2m
CB01PT-4	Cable diameter 4mm, length 2m, cable with plastic head
CB01PT-6	Cable diameter 6mm, length 2m, cable with plastic head

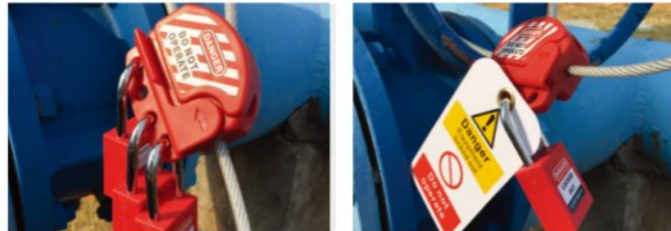

- Includes high-visibility, re-usable, write-on safety labels. Can be customized.
- Ideal for locking out a single valve or multiple side-by-side valves.

Part No.	Description
CB02	Cable diameter 3.3mm, length 2.4m

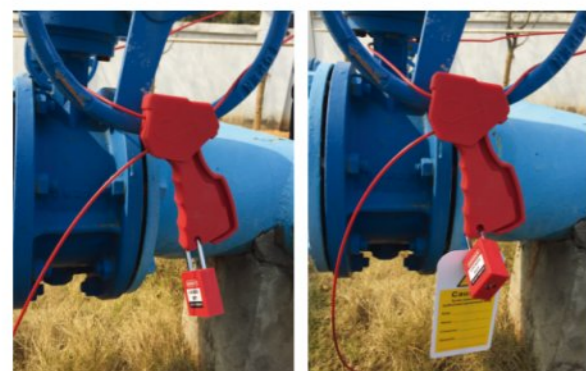

- Lock body: made of glass-filled nylon, withstands chemicals.
- Cable: tough, flexible multi-stranded steel cable, with red insulation coating.
- Cable length can be customized.
- Accepts up to 1 padlock to lock out.
- Can be equipped together with hasps for multiple lockout usage.

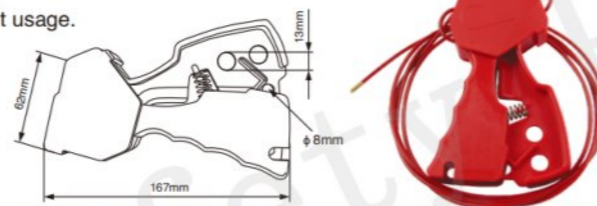

## ADJUSTABLE STEEL CABLE LOCKOUT



Part No.	Description
CB03	Cable diameter 3.8mm, length 2m



- Made from industrial durable nylon, and insulation coated steel cable.
- Designed to effectively lock out a variety of isolation points, including gate valves, "T" valve handles and other hard-to-secure mechanical devices.
- The handle is designed to operate the device without any tools needed.
- Cable length and color can be customized.
- Accepts up to 8 padlocks for multiple lockout application.

Eshop: <https://www.lockey.cz/>

## FISH-SHAPED CABLE LOCKOUT

- Lock body made from ABS, with insulation plastic coated steel cable.
- Accepts up to 6 padlocks for multiple lockout application.
- Cable length and color can be customized.
- Includes high-visibility, re-usable, write-on safety labels. Can be customized.

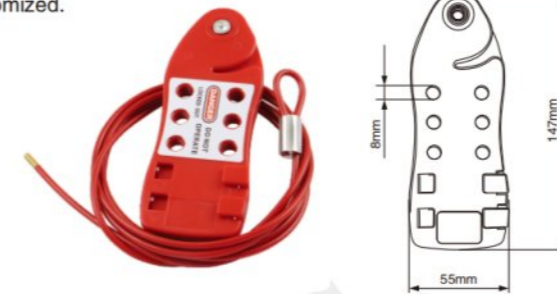

Part No.	Description
CB04	Cable diameter 3.8mm, length 2m



Part No.	Description
CB05	Cable diameter 3.8mm, length 2m

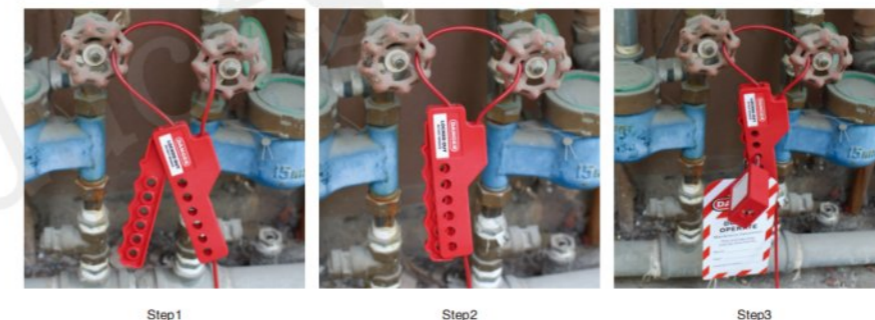

- Made from nylon, with an insulation plastic coated steel cable.
- Accepts up to 6 padlocks for multiple lockout application.
- Non-slip design fits man's hand shape. Very convenient to be used.

- Cable length and color can be customized.
- Includes high-visibility, re-usable, write-on safety labels.

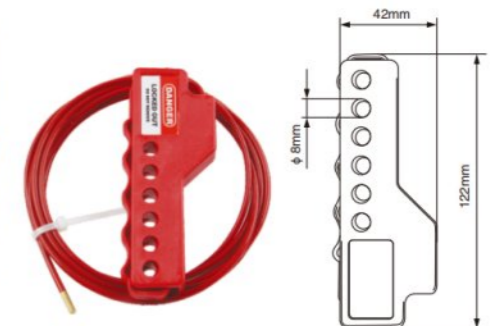

## AUTO RETRACTABLE CABLE LOCKOUT

- Made from durable ABS, with stainless steel cable stored internally, anti-corrosive and temperature-resistant.
- Push button self-winding mechanism retracts automatically to tightly cinch the cable, leaving no slack.
- Designed to effectively lock out different types of disconnect switches and small gate valves.

Part No.	Description
CB06	Cable diameter 1.5mm, length 2m

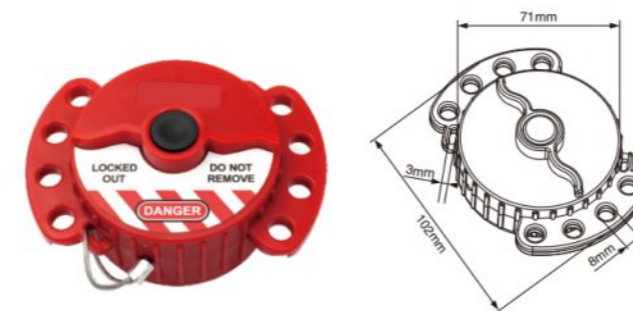

- With auto retractable function, it's easy to operate, compact and portable.
- Accepts up to 8 padlocks for multiple lockout application, locking shackle max diameter 8mm.
- Cable length and color can be customized.

Eshop: <https://www.lockey.cz/>



## CABLE LOCKOUT

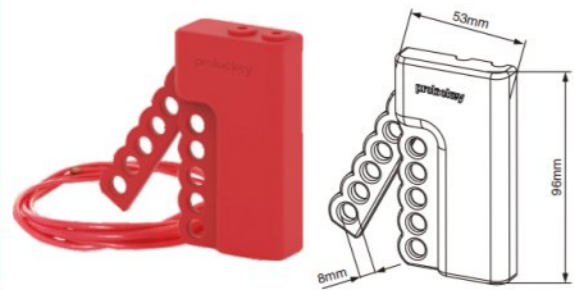

Part No.	Description
CB07-3.2	Cable diameter 3.2mm, length 2.4m, steel cable with plastic coating.
CB07-5	Cable diameter 5mm, length 2.4m, steel cable with plastic coating.

- Made from durable ABS.
- Designed to effectively lock out a variety of energy isolation points as well as difficult-to-secure mechanical devices.
- Available with interchangeable cables, with 3.2mm and 5mm diameter for option.
- Accepts up to 5 padlocks for multiple lockout application.

Part No.	Description
----------	-------------

CB08 Cable diameter 1.5mm, length 300mm

- PA body, with insulation coated steel cable.
- Used to lock the device with small lock hole.
- Accepts up to 2 padlocks for multiple lockout application. The lock hold diameter is 8mm and 6mm.
- Cable length and color can be customized.

## CAR SEAL LOCKOUT



## CABLE LOCKOUT

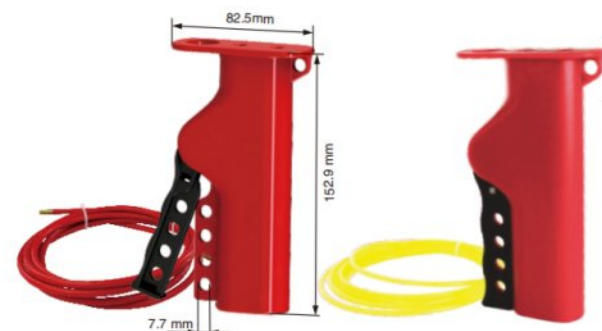

Part No.	Description
CB09	Cable diameter 5mm, length 2.4m, Steel cable with PVC coated.
CB09-3.3P	Cable diameter 3.3mm, length 2.4m, Plastic cable.

- Reinforced durable ABS body, withstand temperature from  $-20^{\circ}\text{C}$  to  $+90^{\circ}\text{C}$ . Steel cable with insulation plastic pvc coated.
- Accepts up to 4 workers for multiple lockout application.
- Cable length and color can be customized.

Part No.	Description
----------	-------------

CB11 Cable diameter 3.8mm, length 2m

- Reinforced nylon PA body, withstand temperature from  $-20^{\circ}\text{C}$  to  $+80^{\circ}\text{C}$ .
- The cable with clear plastic insulation coating.
- Ergonomic design, Pop-Up lock, easy to operate.
- Accepts up to 5 workers for multiple lockout application.

## CABLE LOCKOUT



## UNIVERSAL CABLE LOCKOUT

Part No.	Description
----------	-------------

CB21 Cable diameter 4.3mm, length 2m

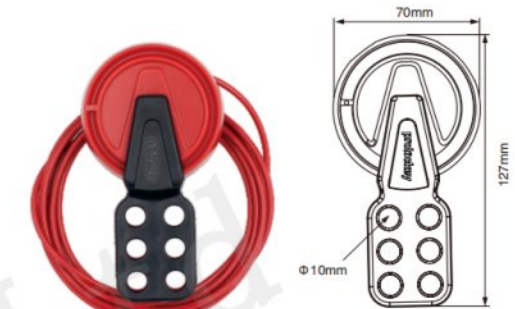
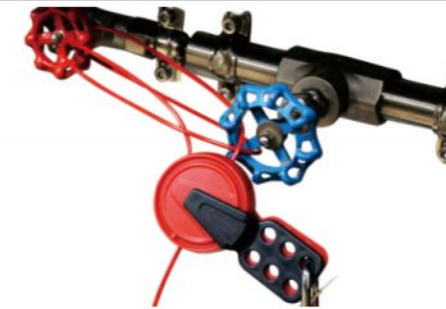

- Made of ABS body withstand chemicals and steel cable with non-conductive nylon coating attachment.
- Lightweight construction for easy handing, carrying and operation.
- Accepts up to 6 padlocks for multiple energy isolation points.

## ADJUSTABLE STEEL CABLE LOCKOUT



Part No.	Description
CB31	Cable diameter 3.3mm, length 2.8m

- Made of strong, impact-resistant alloy, temperature resistance from  $-20^{\circ}\text{C}$  to  $120^{\circ}\text{C}$ .
- Big knob for cable retracting, easier to reel in, anti-slewing function, make the locking safer.
- Suitable for multi-point locking, support 4 people management at same time.
- Stainless steel cable and pure plastic cable available.

Part No.	Material	Description
CS01-2.5S-256	Aluminum alloy body, with galvanized cable	Cable diameter 2.5mm, length 256mm
CS01-2.5S-1000	Aluminum alloy body, with galvanized cable	Cable diameter 2.5mm, length 1000mm
CS02-1.8S-256	ABS body, with steel cable	Cable diameter 1.8mm, length 256mm
CS02-1.8P-256	ABS body, with insulation coated steel cable	Cable diameter 1.8mm, length 256mm

- Ideal for long term uses, each car seal is self locking. The only way to remove it is by cutting after the cable passed through the body.
- All car seals can be laser printed with individually numbering.
- The length of the cable can be customized.
- Colors can be customized, normally in red, yellow, green and blue.

## SECURITY SEAL LOCKOUT

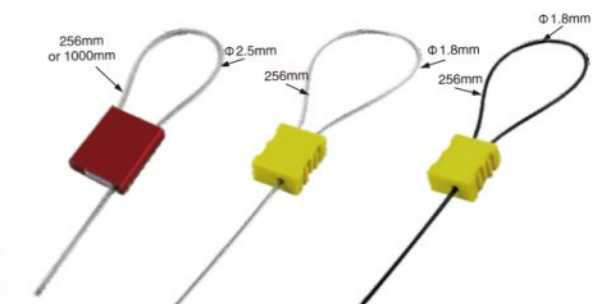

CS01-2.5S-256/1000 CS02-1.8S-256 CS02-1.8P-256





## CIRCUIT BREAKER LOCKOUT

Lock out, stay safe.

Eshop: <https://www.lockey.cz/>

### MINIATURE CIRCUIT BREAKER LOCKOUT

Part No.	Description
POS	POS (Pin Out Standard), 2 holes required, fit up to 60Amp



- Made from engineering plastic strengthened nylon PA.
- Applied for most existing types of European and Asian circuit breakers.
- Suggest to be equipped together with a padlock.
- Easily installed, no tools needed.
- Can take a padlock with shackle diameter up to 9/32"(7.3mm).
- Available for single and multi-pole breakers.

Part No.	Description	MINIATURE CIRCUIT BREAKER LOCKOUT
PIS	PIS (Pin In Standard), 2 holes required, fit up to 60Amp	



- Made from engineering plastic strengthened nylon PA.
- Applied for most existing types of European and Asian circuit breakers.
- Suggest to be equipped together with a padlock.
- Easily installed, no tools needed.
- Can take a padlock with shackle diameter up to 9/32"(7.3mm).
- Available for single and multi-pole breakers.

### MINIATURE CIRCUIT BREAKER LOCKOUT

Part No.	Description
POW	Pin out standard, suitable for small circuit breakers with hole spacing $\leq 17\text{mm}$
POEW	Pin out standard, suitable for small circuit breakers with hole spacing $\leq 20\text{mm}$



- Made from engineering plastic strengthened nylon PA.
- Applied for most existing types of European and Asian circuit breakers.
- Suggest to be equipped together with a padlock.
- Easily installed, no tools needed.
- Can take a padlock with shackle diameter up to 9/32"(7.3mm).
- Available for single and multi-pole breakers.

Eshop: <https://www.lockey.cz/>



### MINIATURE CIRCUIT BREAKER LOCKOUT

Part No.	Description
TBLO	TBLO (Tie Bar Lockout), no hole in breakers required



- Made from engineering plastic strengthened nylon PA.
- Applied for most existing types of European and Asian circuit breakers.
- Suggest to be equipped together with a padlock.
- Easily installed, no tools needed.
- Can take a padlock with shackle diameter up to 9/32"(7mm).
- Available for multi-pole breakers.

Part No.	Description
PIT	Locks out most miniature circuit breakers

### PIN IN TOGGLES CIRCUIT BREAKER LOCKOUT



- Made from durable ABS, temperature resistance -20°C to +90°C.
- Miniature circuit breakers with a lock hole distance of 13 mm.
- Accepts lock shackles up to 9/32" (7.5mm) in diameter.

### PIN OUT TOGGLES CIRCUIT BREAKER LOCKOUT

Part No.	Description
POT	Locks out most miniature circuit breakers



- Made of ABS engineering plastic and PC polycarbonate.
- Suitable for most miniature circuit breakers with an opening of 11 mm or less at the handle part.
- Single person management, lock hole diameter 7.8mm.

### PIN OUT WIDE TOGGLES CIRCUIT BREAKER LOCKOUT

Part No.	Description
POWT	Locks out most miniature circuit breakers



- Made of ABS engineering plastic and PC polycarbonate.
- Suitable for most miniature circuit breakers with an opening of 11 mm and 13mm at the handle part.
- Single person management, lock hole diameter 7.8mm.

Part No.	Description
CBL01-1	lock hole:9mm,max clamping 8mm, need a small screw driver to install.
CBL01-2	lock hole:9mm, max clamping 8mm, without installing tools needed.

### CIRCUIT BREAKER LOCKOUT

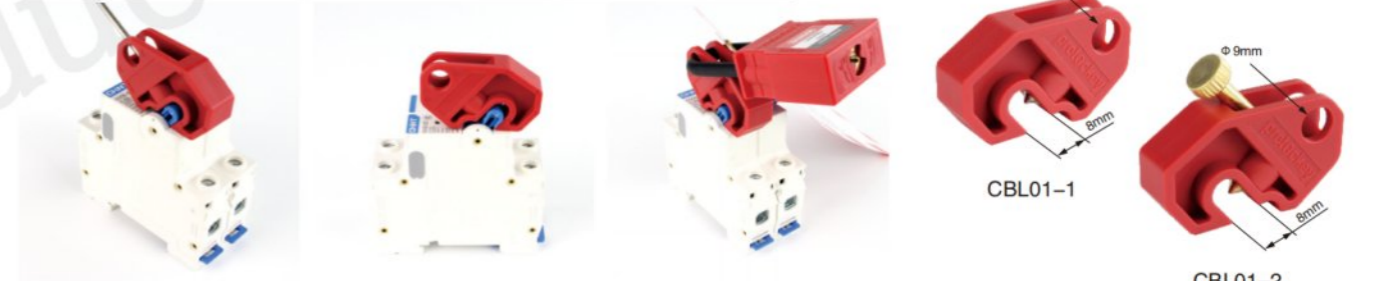

- Made from engineering plastic strengthened nylon PA.
- Lock out different types of circuit breakers.

### CIRCUIT BREAKER LOCKOUT

Part No.	Description
CBL01S	Max clamping 7.5mm, need a small screw driver to install.

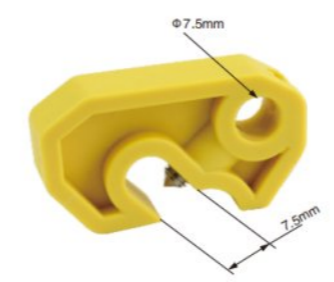

- Made of PA reinforced nylon, temperature resistant from -20°C to +120°C.
- Suitable for most miniature and small circuit breaker lockouts.
- Single management lock hole.



**CIRCUIT BREAKER LOCKOUT**

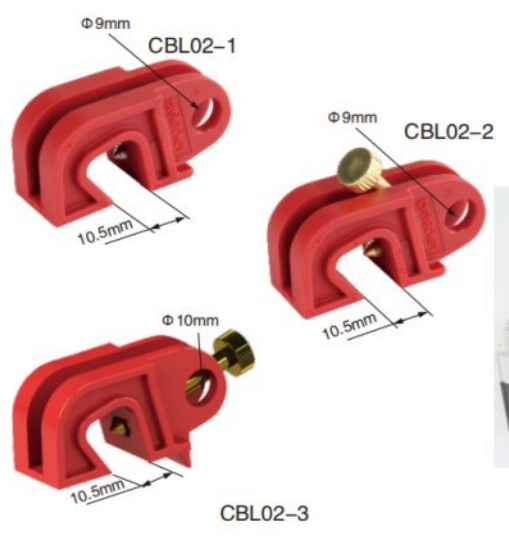

Part No.	Description
CBL02-1	lock hole:9mm, max clamping 10.5mm, need a small screw driver to install.
CBL02-2	lock hole:9mm, max clamping 10.5mm, without installing tools needed.
CBL02-3	lock hole:10mm, max clamping 10.5mm, without installing tools needed.

- Made from engineering plastic strengthened nylon PA.
- Lock out different types of circuit breakers.

**CIRCUIT BREAKER LOCKOUT**

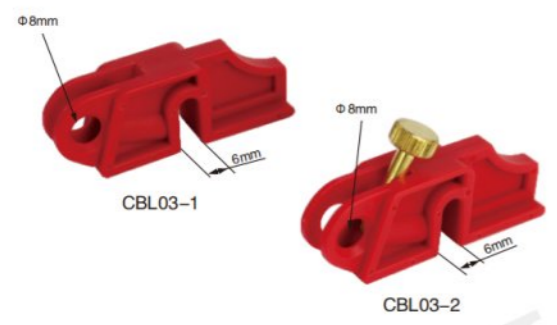

Part No.	Description
CBL03-1	Hole diameter 8mm, need a small screw driver to install.
CBL03-2	Hole diameter 8mm, without installing tools needed.

- Made from engineering plastic strengthened nylon PA.
- Lock out different types of circuit breakers.

Part No.	Description
CBL04-1	Hole diameter 8.5mm, need a small screw driver to install.
CBL04-2	Hole diameter 8.5mm, without installing tools needed.

- Made from engineering plastic strengthened nylon PA.
- Lock out different types of circuit breakers.

**CIRCUIT BREAKER LOCKOUT**

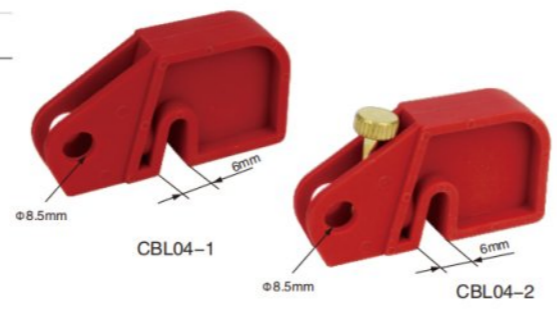

**LARGE MOULDED CASE CIRCUIT BREAKER LOCKOUT**



Part No.	Description
CBL05-1	Max clamping 20.7mm, need a small screw driver to install.
CBL05-2	Max clamping 20.7mm, without installing tools needed.

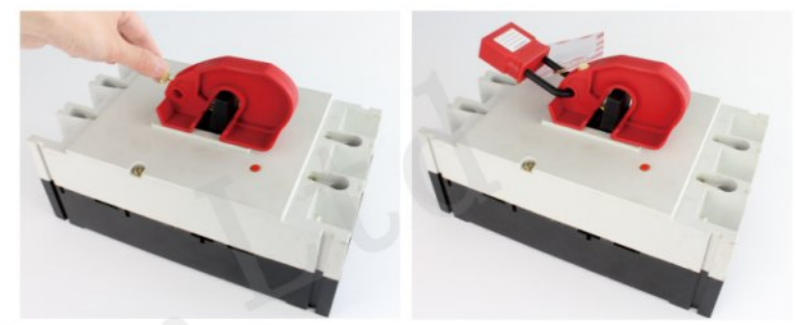

- Made from engineering plastic strengthened nylon PA.
- Lock out different types of circuit breakers.
- Can take a padlock with shackle diameter up to 9.5mm.

Part No.	Product	Description
COCBL1	CBL01-1 x 1 CBL02-1 x 1 CBL03-1 x 1 CBL04-1 x 1 CBL05-1 x 1	Need a small screw driver to install.
COCBL2	CBL01-2 x 1 CBL02-2 x 1 CBL03-2 x 1 CBL04-2 x 1 CBL05-2 x 1	Without installing tools needed.

**COMBINED CIRCUIT BREAKER LOCKOUT SET**

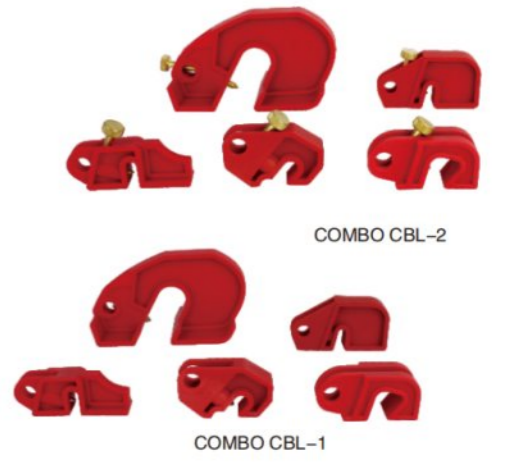

- Made from engineering plastic strengthened nylon PA.
- Each set includes 5 shapes of lockout to lock different types of circuit breakers.

**MULTI-FUNCTIONAL CIRCUIT BREAKER LOCKOUT**

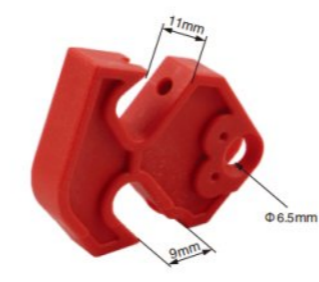

Part No.	Description
CBL06	Suitable for mini-size circuit breaker handle width ≤9mm, and middle size circuit breaker handle width ≤11mm



- Made from engineering plastic strengthened nylon PA.
- Fits on breaker toggles and can be tightened with a screw driver.
- With two toggles can be applied on different sizes of breakers.
- Can take a padlock with shackle diameter up to 6.5mm.



Part No.	Description	CIRCUIT BREAKER LOCKOUT
CBL07	7mm ≤ a ≤ 15mm	



- Made from durable ABS.
- Self-locking screws, easy to lock without tools.
- Wide range of uses: suitable for all kinds of miniature circuit breakers (handle width ≤ 15mm).

**MULTI-FUNCTIONAL CIRCUIT BREAKER LOCKOUT**

Part No.	Description
CBL08	Accept up to 1 padlock with shackle diameter ≤ 10.5mm

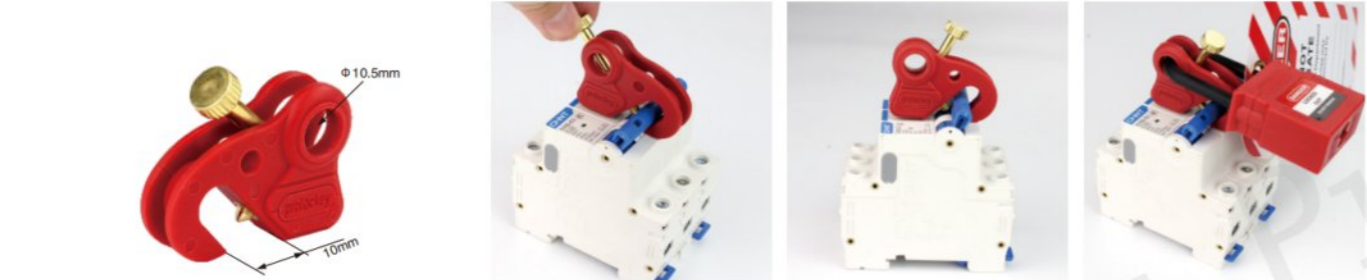

- Made from engineering plastic strengthened nylon PA and brass
- Self-locking screws, easy to lock without tools.
- Wide range of uses: suitable for all kinds of small and medium sized MCCBs, and any miniature circuit breakers (handle width ≤ 10mm).

**CLAMP-ON CIRCUIT BREAKER LOCKOUT**

Part No.	Description
CBL11	For 120–277V breaker lockouts, handle width ≤ 16.5mm



- Made of rugged polypropylene and impact modified nylon.
- Can be easily operated without any tools.
- Can be used with lockout cleats in the bottom for hard locking long sliding switches and switches with large angular rotation.
- Accepts lock shackles up to 9/32" (7.5mm) in diameter.

Part No.	Description	CIRCUIT BREAKER LOCKOUT
CBL11-2	Dedicated to Schneider circuit breakers EZD below 100A	
CBL11-3	Dedicated to Schneider circuit breaker EZD between 160–250A	



- Made of rugged polypropylene and impact modified nylon, temperature resistance -5°C to +100°C.
- Can be easily operated without any tools.
- Accepts lock shackles up to 9/32" (7.5mm) in diameter.

**CLAMP-ON CIRCUIT BREAKER LOCKOUT**

Part No.	Description
CBL12	For 480–600V breaker lockouts, handle width ≤ 41mm



- Made of rugged polypropylene and impact modified nylon.
- Can be used with lockout cleats in the bottom for hard locking long sliding switches and switches with large angular rotation.
- Can be easily operated without any tools.
- Accepts lock shackles up to 9/32" (7.5mm) in diameter.

**CLAMP-ON CIRCUIT BREAKER LOCKOUT**

Part No.	Description
CBL13	For large 480–600V breaker lockouts, handle width ≤ 70mm

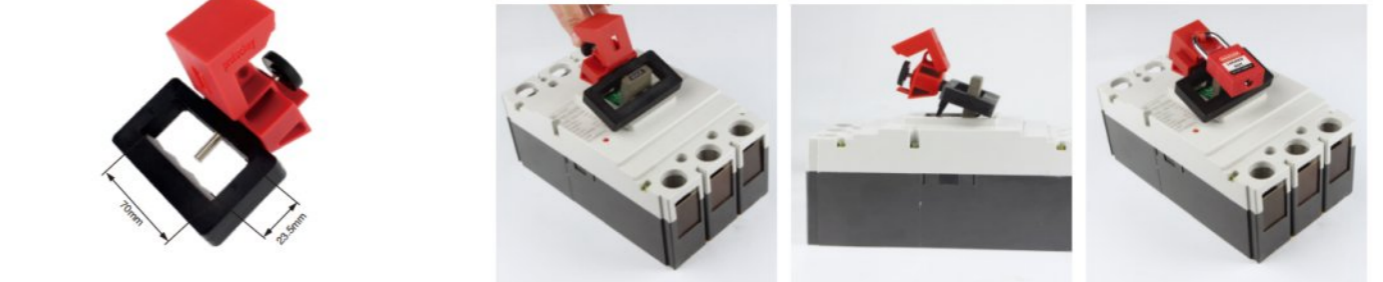

- Made of rugged polypropylene and impact modified nylon.
- Can be easily operated without any tools.
- Can be used with lockout cleats in the bottom for hard locking long sliding switches and switches with large angular rotation.
- Accepts lock shackles up to 9/32" (7.5mm) in diameter.



Part No.	Description	CLAMP-ON CIRCUIT BREAKER LOCKOUT
CBL14	For large 480–600V breaker lockouts, handle width ≤ 70mm	

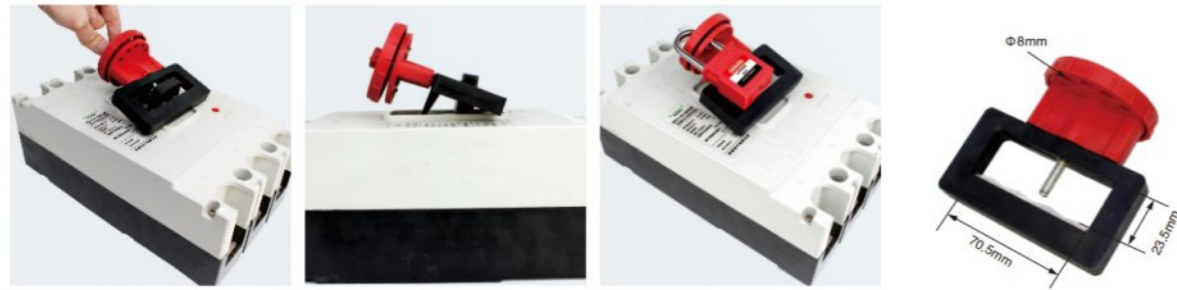

- Made from engineering plastic PC material.
- Self-contained screw for easy lockout. Can be easily operated without any tools.
- Multi-lockholes design enables ten workers to lock at the same time.
- Accepts padlock shackles up to 8mm in diameter.

## CIRCUIT BREAKER LOCKOUT

Part No.	Description
CBL16	Suitable for miniature circuit breakers and small molded case circuit breakers etc.

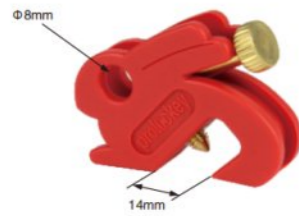

- Made of reinforced nylon PA, temperature resistance -20°C to +120°C.
- Accept 1 management hole.
- Can be easily operated without any tools.

## CIRCUIT BREAKER LOCKOUT

Part No.	Description
CBL31-S-RED	Max clamping 17.5mm

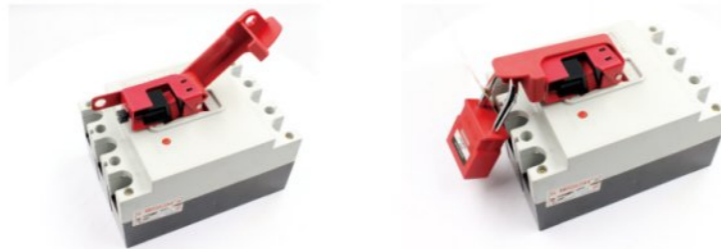

- Material: Die-casting aluminum alloy & Nylon PA & metal spray.
- Fit wide or tall breaker toggles typically found on hi-voltage/hi-amperage breakers.
- Adjust to breaker with a simple thumb turn and then close clamping handle and lock cover to prevent clamp from being loosened.

Part No.	Description	CIRCUIT BREAKER LOCKOUT
CBL32-S-RED	Max clamping 11mm	



- Material: Die-casting aluminum alloy & Nylon PA & metal spray.
- Fit standard height and tie-bar toggles typically found on 120/240V circuit breakers.
- Adjust to breaker with a simple thumb turn and then close clamping handle and lock cover to prevent clamp from being loosened.

MULTI-FUNCTIONAL  
CIRCUIT BREAKER LOCKOUT

Part No.	Description
CBL41	Suitable for locking out multi-pole breakers and works with most tie-bar toggles



- Made from engineering plastic strengthened nylon PA, temperature resistance -20°C to +120°C.
- Compact size allows for locking out adjacent breakers.
- Comes with a locking screw, you can easily lock without using other locking tools. Slotting allows screwdriver adjustment.
- Can take a padlock with shackle diameter up to 8.5mm.

## CIRCUIT BREAKER LOCKOUT

Part No.	Description
CBL42	Suitable for 100A and below molded case circuit breakers



- Made from engineering plastic strengthened nylon PA, temperature resistance -20°C to +120°C.
- Easily installed, no tools needed.
- Can take a padlock with shackle diameter up to 8mm.



**CIRCUIT BREAKER LOCKOUT**

Part No.	Description
CBL42M	Suitable for 100A – 250A molded case circuit breakers



- Made from engineering plastic strengthened nylon PA, temperature resistance -20°C to +120°C.
- Easily installed, no tools needed.
- Can take a padlock with shackle diameter up to 8mm.

Part No.	Description	CIRCUIT BREAKER LOCKOUT
CBL43	Suitable for over 250A molded case circuit breakers	

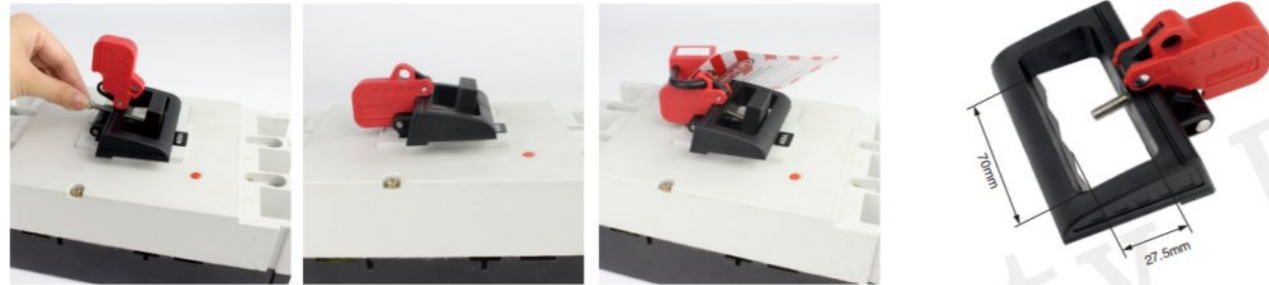

- Made from engineering plastic strengthened nylon PA, temperature resistance -20°C to +120°C.
- Easily installed, no tools needed.
- Can take a padlock with shackle diameter up to 8mm.

**CIRCUIT BREAKER LOCKOUT**

Part No.	Description
CBL51	Max clamping 6.7mm

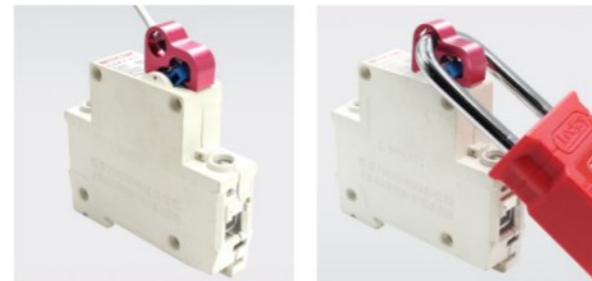

- Made from Aluminum Alloy .
- Fit most existing types of European and Asia Circuit Breaker.
- Fits on breaker toggles and can be tightened with a screw driver.
- Can take a padlock with shackle diameter up to 8.3mm.
- Available for single and multi-pole breakers.

Part No.	Description	CIRCUIT BREAKER LOCKOUT
CBL61	Suitable for push type button motor protection switch, Max clamping 47.5mm.	
CBL62	Suitable for knob type motor protection switch, Max clamping 53.5mm.	



- Made of nylon PA and zinc-alloy, temperature resistance from -20°C to +120°C.
- Tool-free installation, can be locked quickly and easily.
- 8 holes can be fine-tuned for flexible locking, 1 management lock hole.

**CIRCUIT BREAKER LOCKOUT**

Part No.	Description
CBL71	Suitable for the 100A-630A Schneider NSX plastic circuit breaker series.

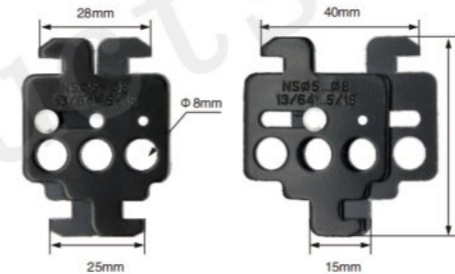

- The lock body is made of standard A3 steel plate, with high temperature spray surface treatment.
- Slide left and right, adjust the card head in two gears.
- Suitable for multi-lock management.
- Designed to lock Schneider medium and large plastic case circuit breakers in the closed state.

Part No.	Description	MINIATURE CIRCUIT BREAKER LOCKOUT
CBL81	Suitable for Chint, Delixi, ABB, Schneider and other small circuit breakers.	

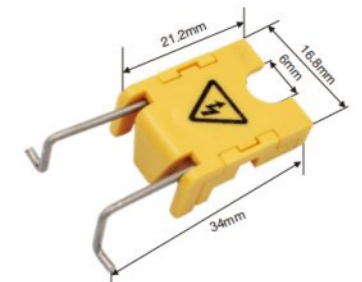
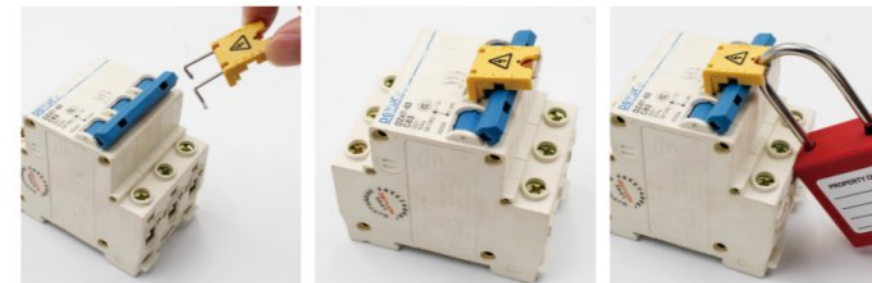

- Made of engineering plastic .
- Applied for most existing types of European and Asian circuit breakers.
- Suggested to be equipped together with a padlock for added safety.
- Easily installed, no tools needed.
- Available for single and multi-pole breakers.



### MINIATURE CIRCUIT BREAKER LOCKOUT



- Made from durable ABS .
- Easily installed, no tools needed.

Part No.	Description
CBL91	Suitable for Schneider IC65 or IC65N series single or multi-pole miniature circuit breakers

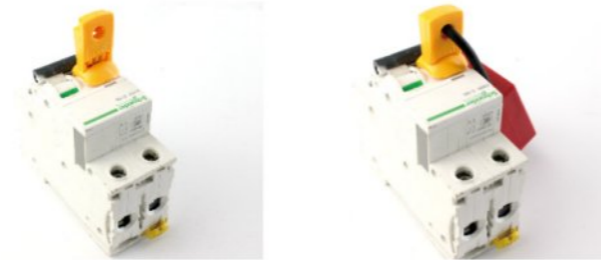

- Can take a padlock with shackle diameter up to 6.2mm.

### SNAP-ON CIRCUIT BREAKER LOCKOUT

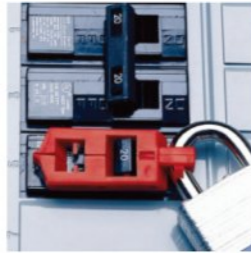
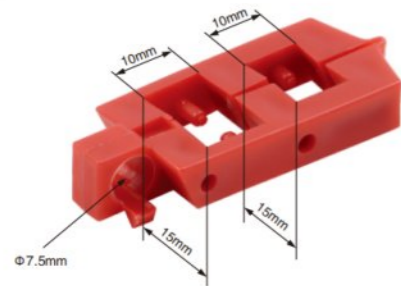

Part No.	Description
CBL21	For 120V circuit breakers which have holes in the switch tongue

- Made from engineering plastic strengthened nylon PP.
- For 120V circuit breakers which have holes in the switch tongue.
- Quick and easy usage– just snap it into place and apply padlock.
- Accepts lock shackles up to 10mm in diameter.

Part No.	Description	CIRCUIT BREAKER LOCKOUT
CBL101	Locks out most miniature circuit breakers	



- Made from engineering plastic strengthened nylon PA, temperature resistance  $-20^{\circ}\text{C}$  to  $+120^{\circ}\text{C}$ .
- Suitable for most miniature circuit breakers with an opening of 11 mm or less at the handle part.
- Accepts lock shackles up to 8mm in diameter.

### LARGE MOULDED CASE CIRCUIT BREAKER LOCKOUT

Part No.	Description
CBL201	Suitable for specific or small handle push distance large moulded case circuit breakers.
CBL201-H	Suitable for most of the slot with small handle push distance large moulded case circuit breakers.

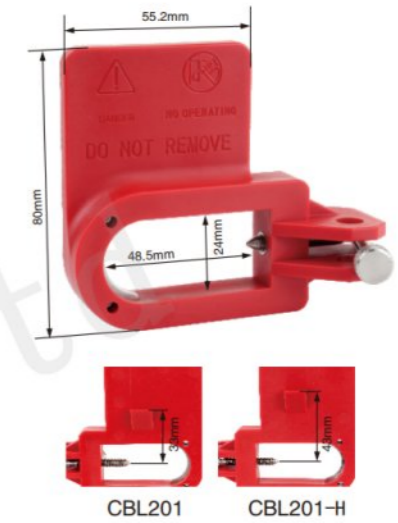

- Made of reinforced nylon PA, temperature resistance  $-20^{\circ}\text{C}$  to  $+120^{\circ}\text{C}$ .
- Single-Person management, lock hole diameter 7.8mm.
- Easily installed, no tools needed.

### CIRCUIT BREAKER BLOCKING BAR LOCKOUT

Part No.	Description
GCBL01	The length of the rod is 195mm

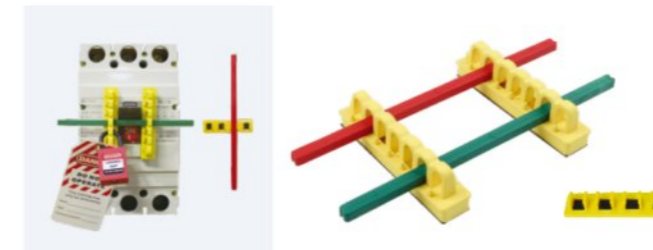

- The base is made of engineering plastic ABS and the main rod is made of nylon PA.
- The back self-adhesive track can be permanently fixed to the switchboard, simply clean the disk and paste it, without drilling.
- A perfect lockout solution for oversized or irregularly shaped switches.
- Colored bars indicates the switch position. Red bar means the switch is in the off state, green bar means the switch is in the on state.





## PNEUMATIC & ELECTRICAL LOCKOUT

Lock out, stay safe.

Eshop: <https://www.lockey.cz/>

### PNEUMATIC QUICK-DISCONNECT LOCKOUT



Part No.	Description
ASL01	Fits 12, 13, 16mm screwed joints.

- Made from engineering plastic nylon PA.
- No need to install a straight interlock valve, can be isolated pneumatic power with lower cost and more convenience.
- Hole in the center of the device allows permanent storage on the air hose and a loop on the side can be used to hang the hose and lockout device.
- Can be equipped with padlocks, lock shackle diameter up to 8mm.

Part No.	Description
ASL02	Suitable for 7–20mm gas source

- Made from 304 stainless steel, corrosion resistance.
- Prevents pneumatic fitting from being connected to pressurized air source.
- Fits virtually all male pneumatic fittings found in manufacturing facilities.
- Measures 1–3/8" wide x 7–3/4" length x 1/8" thick (3.5cm x 19.6cm x 0.3cm).
- Suitable for 2 padlocks, lock shackle diameter ≤8.5mm.

### AIR SOURCE LOCKOUT

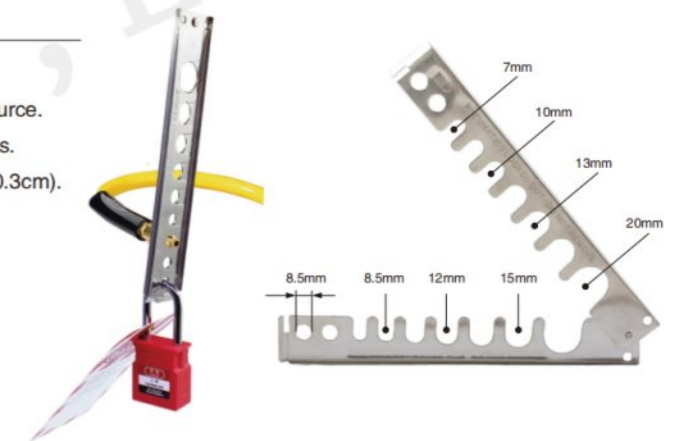

### CYLINDER TANK LOCKOUT



ASL03

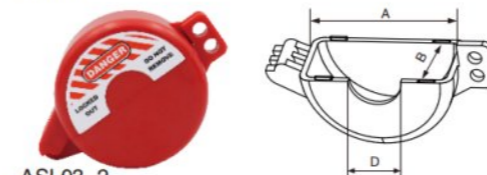

ASL03-2

Part No.	A	B	C	D
ASL03	92	40	33	45
ASL03-2	83	37	/	31

- Made from durable ABS.
- The whole product is metal-free for superior spark proof and chemical resistance.
- Resistant to cracking and abrasion extreme weather and temperature conditions.
- Can be equipped together with hasps and padlocks.

Part No.	Description
ASL04	The neck rings up to 35mm

- Made from engineering plastic ABS.
- Prevent accesses to the main cylinder valve.
- Accommodates neck rings up to 35mm, and max diameter inside 83mm.
- Easy and efficient installation to save your time.
- Can be locked with 3 padlocks, lock shackle diameter up to 8.5mm.

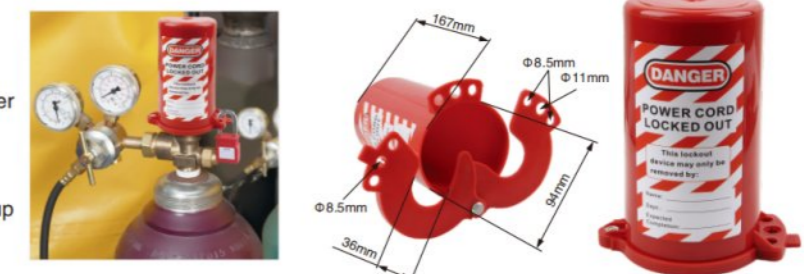

Eshop: <https://www.lockey.cz/>



**ELECTRICAL PLUG LOCKOUT**

Part No.	Description	A	B	C	d1	d2
EPL01	For 110V plugs	89	51	51	12.7	9.5
EPL01M	For 220V plugs	118.5	65.5	65.6	18	9
EPL02	For large 220V/500V plugs	178	85.6	84	26	9



- Made from rugged ABS.
- Prevent plugs from being inserted into the wall outlet, suitable for all kinds of industrial plugs.
- The plug completely sits inside the unit with the cable being fed through an access hole inside.
- Can be locked with 2-4 padlocks, lock shackle diameter up to 9mm.

Part No.	Description
EPL03	Can lock 5 kinds of pneumatic plug lockout with diameter: 8mm, 10mm, 11mm, 12mm, 19mm

- Made from durable ABS.
- Several different hole sizes can be applied for a variety of electrical plugs.
- Holes are designed to fit "necked down" pneumatic male fittings commonly attached to compressed air hoses.
- Available for all kinds of electrical and pneumatic plugs.
- Recommended to use in combination with a padlock for added safety, up to 4 padlocks with shackle diameter up to 7.9mm.

**PNEUMATIC PLUG LOCKOUT**

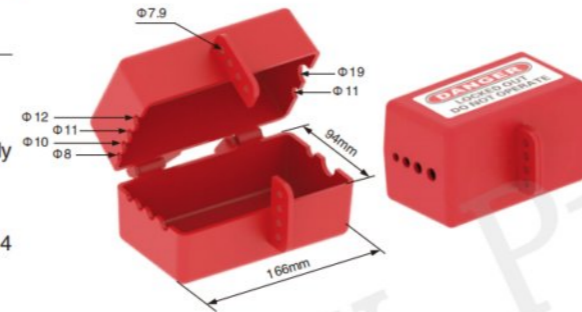

**ELECTRICAL PLUG LOCKOUT**

Part No.	Description	A	B	C	d1
EPL04	Suitable for plugs ≤ 58mm in size	110	70	21	7
EPL05	Suitable for plugs ≤ 78mm in size	190	90	25	7

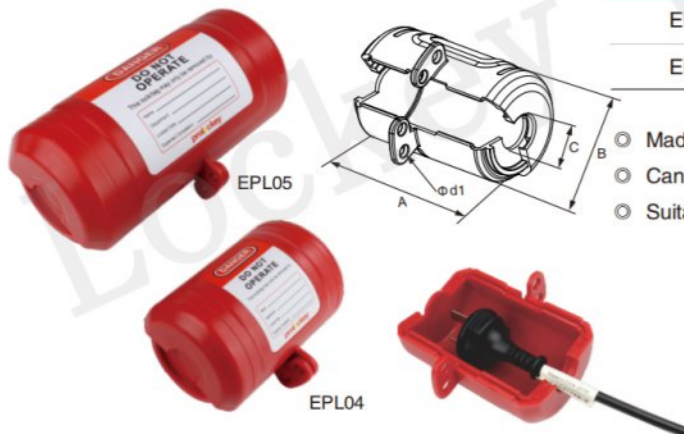

- Made of ABS engineering plastic, Temperature resistance -20°C to +90°C.
- Can be managed by 2 person at the same time.
- Suitable for industrial and domestic plug locking.

**EMERGENCY STOP LOCKOUT**

Part No.	Description
SBL01-D22	Height: 31.6mm; outer diameter: 49.8mm; inner diameter 22.5mm
SBL01M-D25	Height: 31.6mm; outer diameter: 49.8mm; inner diameter 25.5mm
SBL02-D30	Height: 31.6mm; outer diameter: 49.8mm; inner diameter 30mm

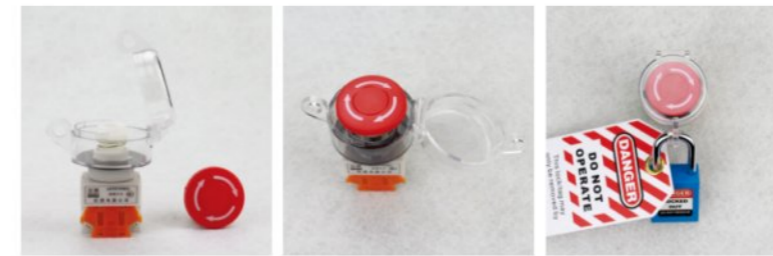

- Made from durable transparent PC.
- Fits on press or screw emergency stop button.
- Easily used and permanently prevent workers from operating carelessly.
- Fits both 22.5mm-30mm diameter switches.

Part No.	Description
SBL03-1	With components C1, C2 and C4
SBL03-1-C1	Locking diameter: 22mm
SBL03-1-C2	Locking diameter: 31mm
SBL03-1-C3	With 3M sticker, locking diameter within 39mm.
SBL03-1-C4	Cover component



**EMERGENCY STOP LOCKOUT**

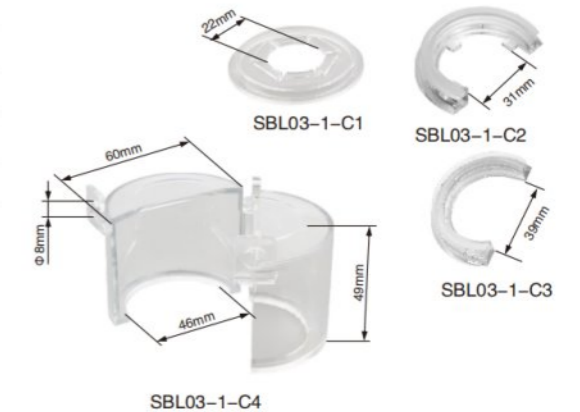

- Made of transparent PC.
- It prohibits access to a switch or control.

- Horse-show shaped retrofit base can be used on raised nameplates and off-center installation to accommodate rotary switch knobs.
- Accommodates buttons up to 50mm diameter and 45mm tall.
- Fits both 31mm and 22mm diameter switches.

**EMERGENCY STOP LOCKOUT**

Part No.	Description
SBL05	Hole diameter: 22.5mm
SBL06	Hole diameter: 30mm



- Made of transparent PC.
- Prohibits access to a switch or control.
- Fits 22.5mm-30mm diameter switches.
- Prevents workers from operating for a mistake.



Part No.	Description	EMERGENCY STOP LOCKOUT
SBL07	Hole diameter: 22mm; inner height: 35mm	
SBL08	Hole diameter: 30mm; inner height: 35mm	

- Made from durable transparent PC.
- Fits on press or screw emergency stop button.
- Easily used and permanently prevent workers from operating carelessly.
- Fits both 22mm–30mm diameter switches.

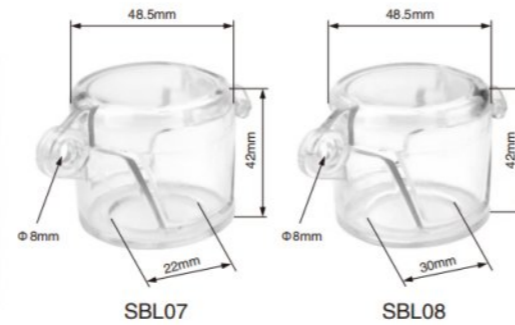

## EMERGENCY STOP LOCKOUT

Part No.	Description
SBL09	Hole diameter: 22.7mm; inner height: 47mm
SBL10	Hole diameter: 29.8mm; inner height: 47mm

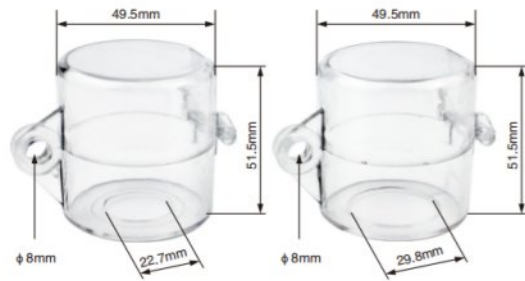

- Made from durable transparent PC.
- Fits on press or screw emergency stop button.
- Easily used and permanently prevent workers from operating carelessly.
- Fits both 22.7mm–29.8mm diameter switches.

Part No.	Description	SAFETY LOCKOUT BAG
LB11	442mm(L) × 248mm(W)	
LB12	647mm(L) × 248mm(W)	

- Made from flexible and durable fabric.
- Effectively locks out odd size and large electrical connectors and hoist controls.
- Flexible and durable ripstop nylon bag fits easily in safety tool boxes.
- Warning sign can be customized.



## MANHOLE LOCKOUT BAG

Part No.	Description
MHL01	Size: 485mm(W)×420mm(H), cable lockout need to buy separately.

- Made from wear resisting polyester cloth.
- With 5 meters cable lockout, can lock kinds of manhole.
- Print warning sign on the surface, warning sign can be customized.



Part No.	Description	DISCONNECTOR LOCKOUT
ECL11	Suitable for 35–85mm disconnector	

- The base is made of engineering plastic ABS and the main rod is made of nylon PA.
- The back self-adhesive track can be permanently fixed to the switchboard, simply clean the disk and paste it, without drilling.
- Lock the 35–85mm height disconnector.
- Colored bars indicates the switch position. Red bar means the switch is in the off state, green bar means the switch is in the on state.

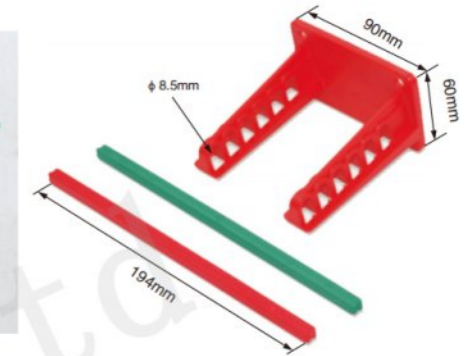
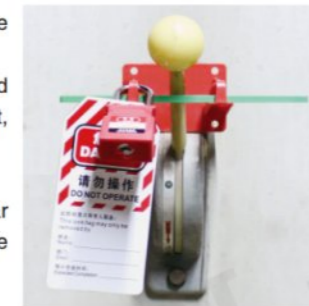

## INDUSTRIAL PLUG LOCKOUT

Part No.	Description
EPL11	Suitable for 6–125A industrial plugs



- Made from engineering plastic ABS material.
- With a compact, light body, professional for locking most types of industrial plugs.
- Labels can be customized.
- Universally used to lock out all sizes of industrial plugs without any tools needed.
- Suggested to be used together with padlocks. Hasps can be used together for multiple usage.

Part No.	Description	WALL SWITCH BUTTON LOCKOUT
WSL02	Size: 158mm × 64mm × 98mm	

- Made from transparent high-strength glass resin PC material.
- Permanently installed on all kinds of switches and other electrical appliances, you need to open the lock to operate that prevent accidental collision.
- Can be fixed by tapping screws or 3M double-sided tape.





**BUTTON LOCKOUT**

Part No.	Description
WSL05	Suitable for switch and panel clearance $\geq 2$ mm transfer switch

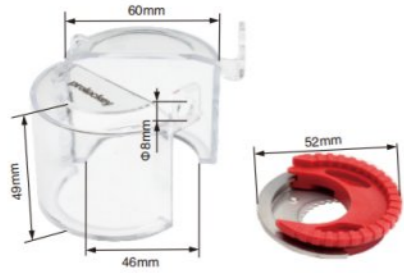

- Made from PC polycarbonate, Temperature resistance  $-20^{\circ}\text{C}$  to  $+120^{\circ}\text{C}$ .
- Easy to install, ready to use.
- Used in safety protection for chemical, power station, steel, workshop and other equipment maintenance.
- 1 lock hole position.

**WALL SWITCH COVER**

Part No.	Description
WSL11	Size:119mm x 45mm x 26mm



- Made of engineering ABS and PC, temperature resistance  $-20^{\circ}\text{C}$  to  $+90^{\circ}\text{C}$ .
- Visualization panel, easy to know whether the switch is on or off.
- 2 sizes adjustable to lock out the wall switches.
- All languages or labels can be customized.

Part No.	Description
WSL21	Size of the base:75mm x 75mm & 88mm x 88mm

- Made from transparent high-strength glass resin PC material.
- Permanently installed on the wall switch or switch and other electrical appliances, you need to open the lock to operate.
- Removable base and side parts.Hole design on both sides, can also lock the plug on the wall, not easy to pull out.
- Can be fixed by tapping screws or 3M double-sided tape.

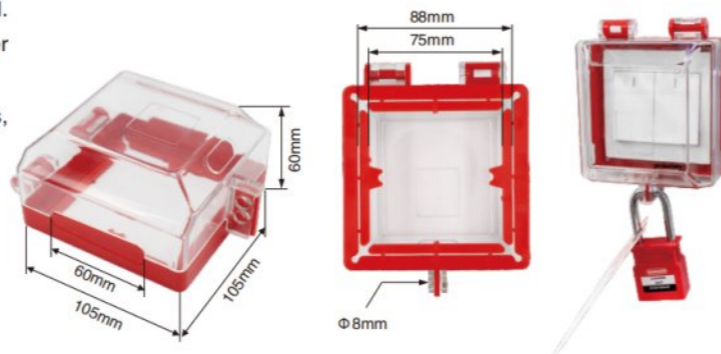

**WALL SWITCH BUTTON LOCKOUT**

**WALL SWITCH BUTTON LOCKOUT**

Part No.	Description
WSL31	Size :80mm x 80mm x 60mm

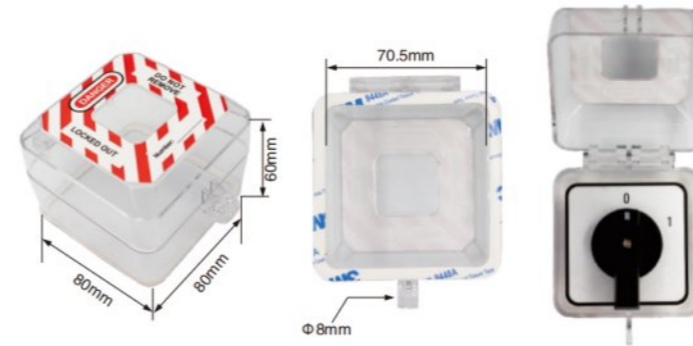

- Made from transparent high-strength glass resin PC material.
- Easy to install, just paste it on the switch cabinet
- Used for chemical industry, power station, steel, workshop and other equipment maintenance safety protection.
- It is suitable for change-over switch or industrial electric switch with external dimension less than 70mm.

**WALL SWITCH BUTTON LOCKOUT**

Part No.	Description
WSL41	Hole diameter:26mm(L) x 12mm(W)



- Made from transparent high-strength glass resin PC material.
- Suitable for locking US standard wall switch.
- Easily used and permanently prevent workers from operating carelessly.

Part No.	Description
SBL31	Size of the base:31.8mm x 25.8mm

- Made from transparent high-strength glass resin PC material.
- Suitable for standard boat shape switch.
- Shackle diameter up to 7mm.



**BUTTON SWITCH LOCKOUT**



### BUTTON SWITCH LOCKOUT

Part No.	Description
SBL41	Hole diameter: 22mm, 30mm



- Made of polycarbonate, temperature resistance -20°C to +120°C.
- The lockout diameter is 22mm, can be expanded to 30mm after removing the easy disassembly part.
- For locking electrical buttons such as emergency stop button.
- Can be managed by 2 people at the same time.

### EMERGENCY STOP BUTTON LOCKOUT

Part No.	Description
SBL51	Hole diameter: 28mm



- Made of polycarbonate, temperature resistance -20°C to +120°C.
- Specially designed for locking Siemens emergency stop switch or emergency stop switch with shields in tight locations.
- Suitable for chemical, food, pharmaceutical and other situations.
- Can be managed by 2 people at the same time.

### ELECTRICAL HANDLE LOCKOUT

Part No.	Description
PHL01	Red belt: 280mm(L) x 25mm(W)



- Made of durable industrial ABS, withstand temperature from -20°C -90°C.
- It consists of a orange base (with 3M glue), two adjusters and a red belt.
- Very easy to install, just stick the body to the panel, and fasten the belt to suitable position, then put padlock and tag together to lock.
- Widly used in Electrical, oil and medical industry.

### MULTI-FUNCTIONAL INDUSTRIAL ELECTRICAL LOCKOUT

Part No.	A	B	C
ECL01	45.5	45	17
ECL02	45.5	45	17
ECL03	45.5	45	17
ECL04	45.5	45	17
ECL05	45.5	45	17
ECL06	45.5	45	17
ECL07	45.5	45	17

- The lock body is made of ABS and the metal is made of iron chrome.
- Can achieve a variety of non-standard electrical or distribution cabinet lock.
- Can be fixed by screws or 3M double-sided tape.
- Different shapes of locks can be designed according to customer requirements.

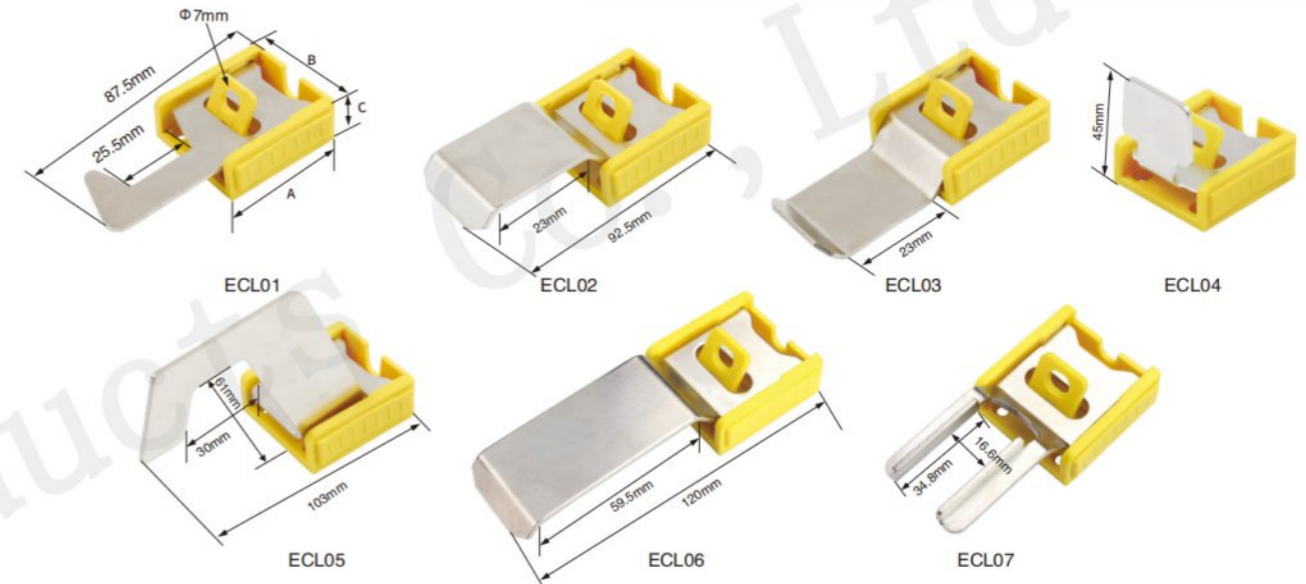





## LOCKOUT HASP

Lock out, stay safe.

Eshop: <https://www.lockey.cz/>

## STEEL LOCKOUT HASP

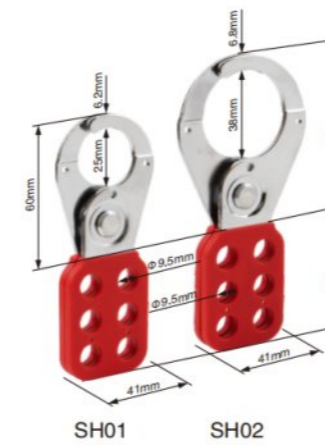

Part No.	Description
SH01	Jaw Size 1"(25mm), accept up to 6 padlocks.
SH02	Jaw Size 1.5"(38mm), accept up to 6 padlocks.

- Handle is made from PA and lock shackle is made from chrome plated steel with red plastic or vinyl coated body, rust proof.
- Allow multiple padlocks to be used when isolating one energy source.
- Lock holes: 9.5mm in diameter.
- Jaw size: 1"(25mm) & 1.5"(38mm).

Part No.	Description
SH01-H	Jaw Size 1"(25mm), accept up to 6 padlocks.
SH02-H	Jaw Size 1.5"(38mm), accept up to 6 padlocks.

## STEEL LOCKOUT HASP WITH HOOK

- Handle is made from PA and lock shackle is made from chrome plated steel with red plastic or vinyl coated body, rust proof.
- Steel lockout hasp includes tamper-proof interlocking tabs to prevent unauthorized opening.
- Lock holes: 9.6mm in diameter.
- Jaw size: 1"(25mm) & 1.5"(38mm).

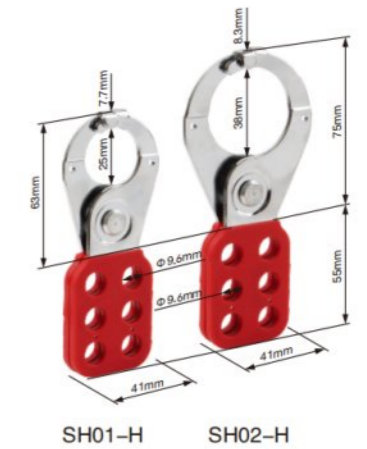

## ECONOMIC STEEL LOCKOUT HASP

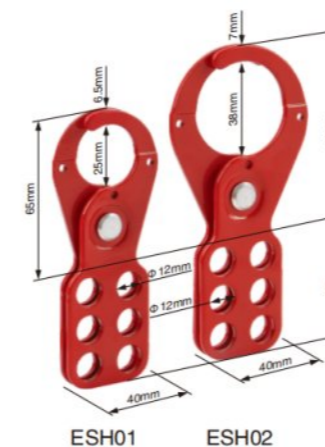

Part No.	Description
ESH01	Jaw Size 1"(25mm), accept up to 6 padlocks.
ESH02	Jaw Size 1.5"(38mm), accept up to 6 padlocks.

- Made from durable steel with red plastic or vinyl coated body, rust proof.
- Can be locked out by multiple workers on a single energy point, by attaching devices on the equipment.
- Lock holes: 12mm in diameter.
- Jaw size: 1"(25mm) & 1.5"(38mm)

Eshop: <https://www.lockey.cz/>



## ECONOMIC STEEL LOCKOUT HASP WITH HOOK

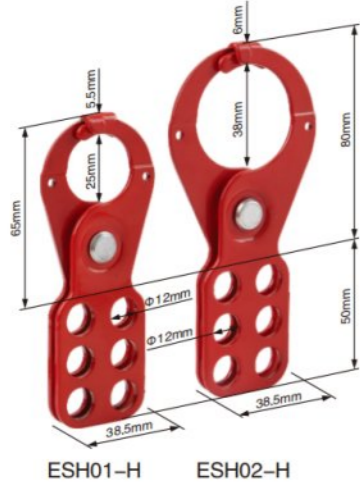

Part No.	Description
ESH01-H	Jaw Size 1"(25mm), accept up to 6 padlocks.
ESH02-H	Jaw Size 1.5"(38mm), accept up to 6 padlocks.

- Made from hardened powder coated steel, durable and resist rust.
- It has a double locking arrangement. Hooks on jaws prevent them to be pulled apart.
- Lock holes: 12mm in diameter.
- Jaw size: 1"(25mm) & 1.5"(38mm).

Part No.	Description
DSH01	Head shackle size: 46mm x 30mm, tail shackle size: 20.5mm x 17mm, length: 136mm

- Made from red sprayed steel.
- Allow multiple padlocks to be used when isolating one energy source.
- Lock holes: 11mm in diameter.
- Overall length: 136mm, with 20.5mm and 46mm jaws.

## DOUBLE-END STEEL LOCKOUT HASP

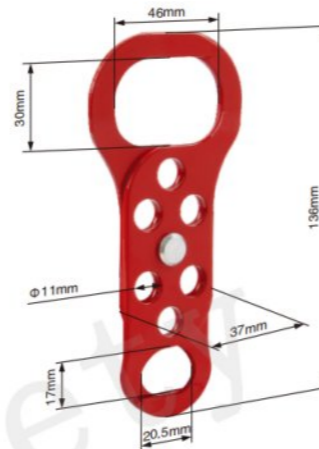

## NYLON LOCKOUT HASP



Part No.	Description
NH01	Overall size: 44 x 175mm, accept up to 6 padlocks.
NH02	Overall size: 41mm x 190mm, accept up to 6 padlocks.
NH03	Overall size: 39.5mm x 114mm, accept up to 3 padlocks.

- Made from durable nylon.
- Non-conductive body, applied to electric power isolation with high requirements on corrosive and explosion-proof places.
- Allow multiple padlocks to be used when isolating one energy source.
- Labels can be customized.

Eshop: <https://www.lockey.cz/>

## NYLON LOCKOUT HASP

Part No.	Description
NH04	Overall size: 61.5 x 105mm, accept up to 4 padlocks.
NH05	Overall size: 61.5 x 106mm, accept up to 4 padlocks.

- Made from nylon.
- Non-conductive body, applied to lock out electric power isolations with high requirements on corrosive or explosion-proof places.
- With 3 mm or 6 mm shackle diameter available.



## ALUMINUM LOCKOUT HASP

Part No.	Description
AH11	Jaw Size 1"(25mm), accept up to 6 padlocks.
AH12	Jaw Size 1.5"(38mm), accept up to 6 padlocks.

- Made from surface treated and spark proof aluminum shackle with red nylon coated body.
- Allow multiple padlocks to be used when isolating one energy source.
- Lock holes: 9mm in diameter.
- Jaw size: 1"(25mm) & 1.5"(38mm).

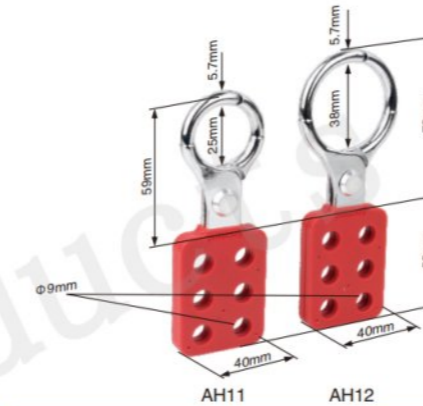

Part No.	Description
DAH01	Head shackle size: 38mm, tail shackle size: 25mm, length: 151mm

- Made from aluminum with surface treatment, spark proof.
- Allow multiple padlocks to be used when isolating one energy source.
- Color can be custom made. Logo printing by laser available.
- Overall length: 151mm, with 25mm and 38mm jaws.

## DOUBLE-END ALUMINUM LOCKOUT HASP

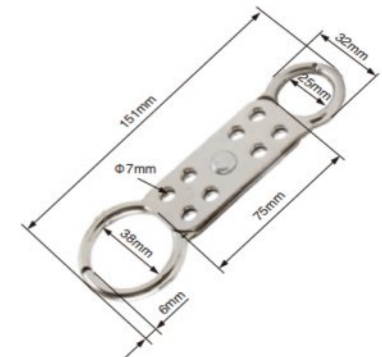

## LOCKOUT HASP

Part No.	Description
ZH01	Jaw Size 1"(25mm), accept up to 8 padlocks.
ZH02	Jaw Size 1.5"(38mm), accept up to 8 padlocks.

- Main body is made from zinc alloy, handle is PA coated.
- Allow multiple padlocks to be used when isolating one energy source.
- Lock holes: 9mm in diameter.

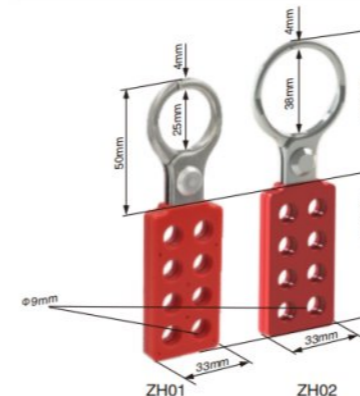

Eshop: <https://www.lockey.cz/>



## ALUMINUM LOCKOUT HASP



Part No.	Description
LAH03	Overall size: 76mm x 189mm , accept up to 8 padlocks.

- Made from anodized aluminum alloy.
- With tamper-proof locking tabs, allowing multiple padlocks to be used when isolating one energy source.
- With a high visibility, re-usable write-on safety label, accepts pencil, pen or marker for repeated use.
- Label and color can be custom made.

Part No.	Description
BAH02	Overall size:59 x 174mm, shackle size: 84mm

- Made from hardened heavy duty steel with rust proof coated.
- Allow multiple padlocks to be used when isolating one energy source.
- Keep equipment inoperative while under repairing or adjusting.

## BUTTERFLY LOCKOUT HASP

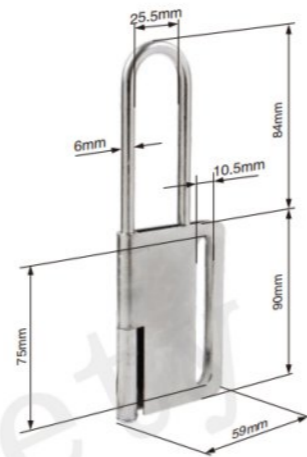

## HOLE SLIDING SAFETY HASP

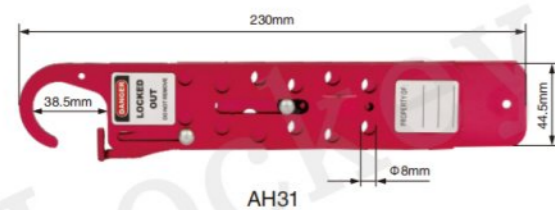

Part No.	Description
AH31	Accept up to 12 padlocks
AH32	Accept up to 24 padlocks

- Anodized aluminum finish for superior corrosion resistance.
- Keeps equipment inoperative while repairs or adjustments are made.
- Control cannot be turned on until last worker's padlock is removed from hasp.
- Offset lockout holes ensure hasp cannot be locked in open position.
- Raised areas for improved sliding action.

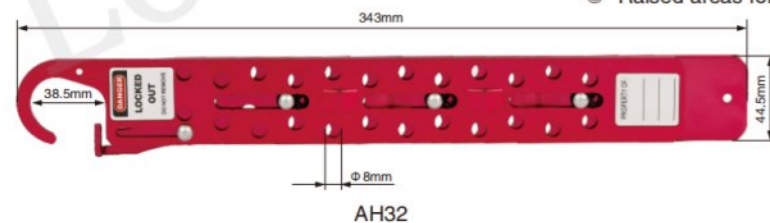

## BUTTERFLY LOCKOUT HASP



Part No.	Description
BAH21	Overall size:57mm x 81mm

- Steel Hasp with Red Plastic Handle.
- The 4mm steel hasp fits smaller lockout points.
- Holds up to 2 safety padlocks.

Part No.	Description
BAH03	Overall size:54.5mm x 112mm

- Made of hard steel, the surface of the lock body is treated by high-temperature spraying.
- Multiple lockout methods.
- Easily manage multiple people together.
- Suitable for chemical industry, machinery manufacturing, electric power and energy industry, etc.

## BUTTERFLY LOCKOUT HASP

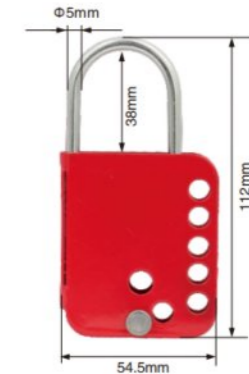

## ALUMINUM LOCKOUT HASP



Part No.	Description
LAH11	Overall size:73mm x 178mm

- Spring type bayonet, more convenient to use.
- The main body is anodized aluminum, and the inside is made of stainless steel, which is more corrosion-resistant.
- Multi-manager.
- Handwritten security label.



## LOCKOUT TAG

Lock out, stay safe.



### SAFETY WARNING TAG

- Made from PVC material.
- The tag indicates who is responsible for placing the lockout device and who is authorized to remove it or make changes to it.
- Can be written by erasable pen for repeated using.
- Other wording and design can be custom made.



Part No.	Description
LT01	75mm(W) × 146mm(H) × 0.5mm(T)
LT02	75mm(W) × 146mm(H) × 0.5mm(T)
LT03	75mm(W) × 146mm(H) × 0.5mm(T)
LT22	85mm(W) × 156mm(H) × 0.5mm(T)

### CUSTOMIZED ID TAG

- Made from PVC.
- You can put any information on the tag, like company name, personal photo, name, contact number or anything else necessary.
- This lockout ID tag is a very direct way to show the person who is in charge and his information.



### SCAFFOLD HOLDER TAG



Part No.	Description
SLT01	Size: 310mm × 92mm, hole diameter: 60mm, 1 tag with 1 holder.
SLT02	Size: 213mm × 56mm, 1 tag with 1 holder.
SLT03	Size: 81mm × 39mm, 1 holder only

- Made from ABS.
- Provides systematic, procedural and legal compliance for scaffolds on work sites.
- Provides a clear inspection trail giving integrity and control of work carried out.
- The tags are available in three durable write-on materials, providing highly visual and eye-catching information.
- Each with a scaffold tag holder and a tag. The tags can be customized.

Part No.	Description
SLT04	Size: 184mm × 260mm, 1 tag with 1 holder

- Made from ABS.
- Provides systematic, procedural and legal compliance for scaffolds on work sites.
- "Do Not Use Equipment" printed on the front.

### LARGE MULTI-FUNCTIONAL SCAFFOLD HOLDER TAG



Eshop: <https://www.lockey.cz/>

Eshop: <https://www.lockey.cz/>



Part No.	Description
TR03-P200	Box: 105mm(W) × 105mm(H) × 90mm(T) Tag: 75mm(W) × 146mm(H) × 0.18mm(T)

### TAG ROLL



- Box features center hole for mounting.
- Perforated for easy separation.
- Prevent accidental or unexpected start-up or release of stored energy when working on equipment or machinery.
- 200 pcs a roll.



## LOCKOUT BOX & STATION

Lock out, stay safe.



**PORTABLE GROUP LOCK BOX**

- Made from surface high temperature spraying plastic treatment steel plate and stainless steel nylon handle.
- Several people can lock the important parts at the same time.
- Can be used as mini portable lockout box, can accommodate several tagout, hasp, mini lockout etc.
- The label message in English. Other language can be custom made.

Part No.	Description
LK01	Size: 227mm(W) × 152mm(H) × 88mm(D), can accommodate 12padlocks.
LK01-2	Size: 227mm(W) × 152mm(H) × 88mm(D), One side has a viewable window.
LK02	Size: 227mm(W) × 152mm(H) × 88mm(D), can accommodate 13padlocks.
LK02-2	Size: 227mm(W) × 152mm(H) × 88mm(D), One side has a viewable window.
LK-WMC	Wall Mounted Components for LK01 and LK02



Part No.	Description
LK03	360mm(W) × 450mm(H) × 163mm(D)
LK03-2	480mm(W) × 600mm(H) × 180mm(D)
LK03-3	600mm(W) × 800mm(H) × 200mm(D)
LK03-4	600mm(W) × 1000mm(H) × 200mm(D)
LK03-P	360mm(W) × 450mm(H) × 163mm(D), Extra 10 hooks
LK03-2-P	480mm(W) × 600mm(H) × 180mm(D), Extra 16 hooks

**MANAGEMENT LOCKOUT STATION**



(Example of Lockout Tagout Products Installation)



- Made from surface high temperature spraying plastic treatment steel plate.
- There are two adjustable separators which can allocate spaces easily.
- The station is multifunctional for all kinds of lockouts, especially for departmental usage.
- Can be customized made non-perspective panel.
- Any size station can be customized.

**METAL PADLOCK STATION**



Part No.	Description
LK04	450mm(W) × 600mm(H) × 85mm(D)

- Made from surface high temperature spraying plastics treatment steel plate.
- With 32 padlock positions, each padlock position can hang 2 padlocks or hasps.
- Other size and specification can be customized.

**METAL PADLOCK STATION**

Part No.	Description
LK04-2	560mm(W) × 460mm(H) × 70mm(D)
LK04-3	580mm(W) × 430mm(H) × 90mm(D)

- Made from surface high temperature spraying plastics treatment steel plate.
- LK04-2 has 30 padlock hooks, with 60pcs padlock capacity.
- LK04-3 has 20 padlock hooks and 4 tag holders capacity.
- Lockout management available.
- Can be customized made non-perspective panel.

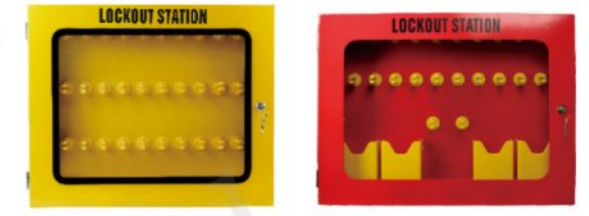

LK04-2 LK04-3

**PORTABLE GROUP LOCK BOX**

Part No.	Description	A(cm)	B(cm)	C(cm)
LK05	Can hold 17pcs padlocks max	33.8	15.2	19
LK06	Can hold 32pcs padlocks max	38.1	22.9	26.7

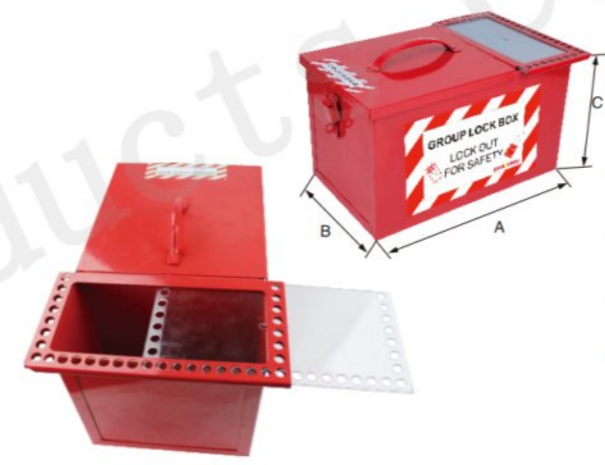

- The Combined Lockout Storage and Group Lockout Box is a handy box which features a lockable storage compartment and a group lockout compartment.
- Made of heavy duty steel, powder coated for extra rust resistance; group lockout compartment has clear PC window with keyhole slot.
- Use one lock on each energy control point and place the keys in the lockout box; each worker then places his own lock on the box to prevent access.
- Each employee retains exclusive control, by placing his own lock on the lockout box containing the keys to the job locks.
- As long as any one worker's lock remains on the lockout box, the keys to the job locks contained inside cannot be accessed.

Part No.	Description
LK07	288mm(W) × 144mm(H) × 128mm(D)

**GROUP LOCKOUT BOX**

- 430-Grade stainless steel construction maximizes corrosion resistance.
- Clear, impact-resistant window provides visibility to secured keys.
- Side window to view unused locks.
- 18 numbered lockout holes for easy identification.
- Latch with lock hole on front for operations lock.
- Flanged design on sides offers easy application of locks.
- Gasketed key slot to drop keys into removable cup.
- Drain holes on bottom to limit liquids from accumulating inside.
- Stackable design facilitates storage and simplifies transporting multiple boxes.
- Replacement removable key cups available.





Part No.	Description
LK21	165mm(W) × 325mm(H) × 85mm(D)

- Made from surface high temperature spraying plastic treatment steel plate and stainless steel and nylon handle.
- Device design for key store when large scale equipment shut down.
- Can be used as mini portable lockout box, can accommodate several tagout, hasps, mini lockout etc.
- Double function: wall mounting type or portable.
- Integrated store space can accommodate 12 padlocks orderly or hundreds of keys scatteredly.
- Up to 14 workers can lock it at the same time.
- Other colors can be customized.

### GROUP LOCKOUT BOX

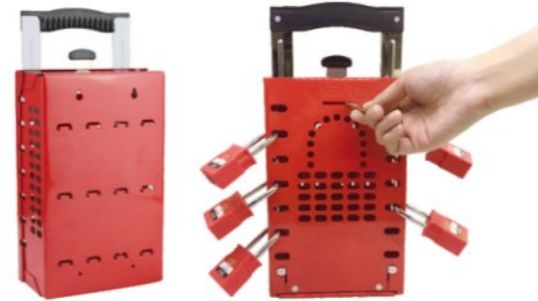

### PLASTIC GROUP LOCK BOX

Part No.	Description
LK31	100mm(W) × 160mm(H) × 120mm(D)

- Made of plastic engineering plastic ABS and PC.
- Visible with mask design.
- Can be locked by 8 safety padlocks at the same time, convenient for administration.
- It has 6 hooks inside and 2 hooks outside.



Part No.	Description
LK32	102mm(W) × 220mm(H) × 65mm(D)

- Made of ABS engineering plastic and PC plastic.
- Visible and transparent panel.
- Can be locked with safety padlock that shackle diameter < 7.8 mm.
- Support 14 people management at same time.
- One piece design with 2 hooks, strong and durable.
- The panel has one key put-in hole, for operation's convenience to put the key back.

### PLASTIC GROUP LOCK BOX



### METAL PADLOCK STATION

Part No.	Description
LK41-1	480mm(W) × 500mm(H) × 85mm(D)

- Made from surface high temperature spraying plastics treatment steel plate.
- LK41-1 has 10 padlock hooks and 2 tag holders capacity.
- Lockout management available.
- Can be customized made non-perspective panel.



Part No.	Description
LK42	440mm(W) × 400mm(H) × 123mm(D) Can accommodate 10 padlocks, several mini lockouts and tags.
LK43	520mm(W) × 540mm(H) × 123mm(D) Can accommodate 20 padlocks, several mini lockouts and tags.

- Made of steel plate with high-temperature spraying treatment on the surface and Acrylic board.
- For the unified storage management of safety padlocks and small lockouts.

### METAL PADLOCK STATION



LK42

LK43

### WALL MOUNTED GROUP LOCK BOX

Part No.	Description
LK71	203mm(W) × 178mm(H) × 57mm(D), can accommodate 7 padlocks.
LK72	430mm(W) × 178mm(H) × 57mm(D), can accommodate 15 padlocks.

- Made of powder coated steel with key slot on top.
- Includes clear Lexan window that slides out when locks are removed.
- Includes key pegs and ID labels to simplify key management, and predrilled holes and hardware for quick mounting.



LK71



LK72

Part No.	Description
LS01	410mm(W) × 315mm(H) × 65mm(D)
LS02	565mm(W) × 400mm(H) × 65mm(D)
LS03	565mm(W) × 400mm(H) × 65mm(D), with holder for small lockout devices.

- Made from engineering plastic PC.
- One piece design, with a cover to lock out.
- Can accommodate padlocks, hasps, lockout tags and some ties.
- There's a lockable combination padlock hole for locking out as a limit access to unauthorized employees.

### LOCKOUT STATION



LS01

LS02

LS03



**LOCKOUT STATION**

Part No.	Description
LS04	560mm(W) × 324mm(H) × 112mm(D), 2 tip-out bins and 8 hooks.
LS05	Combined station for lockout storage



- Made of plastic engineering plastic ABS and PC.
- 8 hanger clips can hold safety padlocks or hasps
- Can accommodate numbers of padlock, hasp, tagout and mini lockout etc.
- Translucent lockable cover protects contents from dust and prevents missing equipment.

Part No.	Description
LS11	Can accommodate 60 padlocks.
LS12	Can accommodate 40 padlocks, 8 hasps and tags.
LS13	Can accommodate 40 padlocks and mini lockouts.
LS14	Can accommodate a number of lockout tags.
LS15	Can accommodate a number of tags and mini lockouts.
LS16	Can accommodate 20 padlocks and 2 writing boards.
LS17	Can accommodate 40 padlocks and 2 phones.
LS18	Can accommodate 6 phones.

**COMBINED LOCKOUT STATION**

- Made from engineering plastic PC.
- One piece design, with a cover to lock out.
- Can accommodate numbers of padlock, hasp, tagout and mini lockout etc.
- There's a lockable combination padlock hole for locking out to limit access to authorized employees.
- The overall size: 520mm(W) × 631mm(H) × 85mm(D).

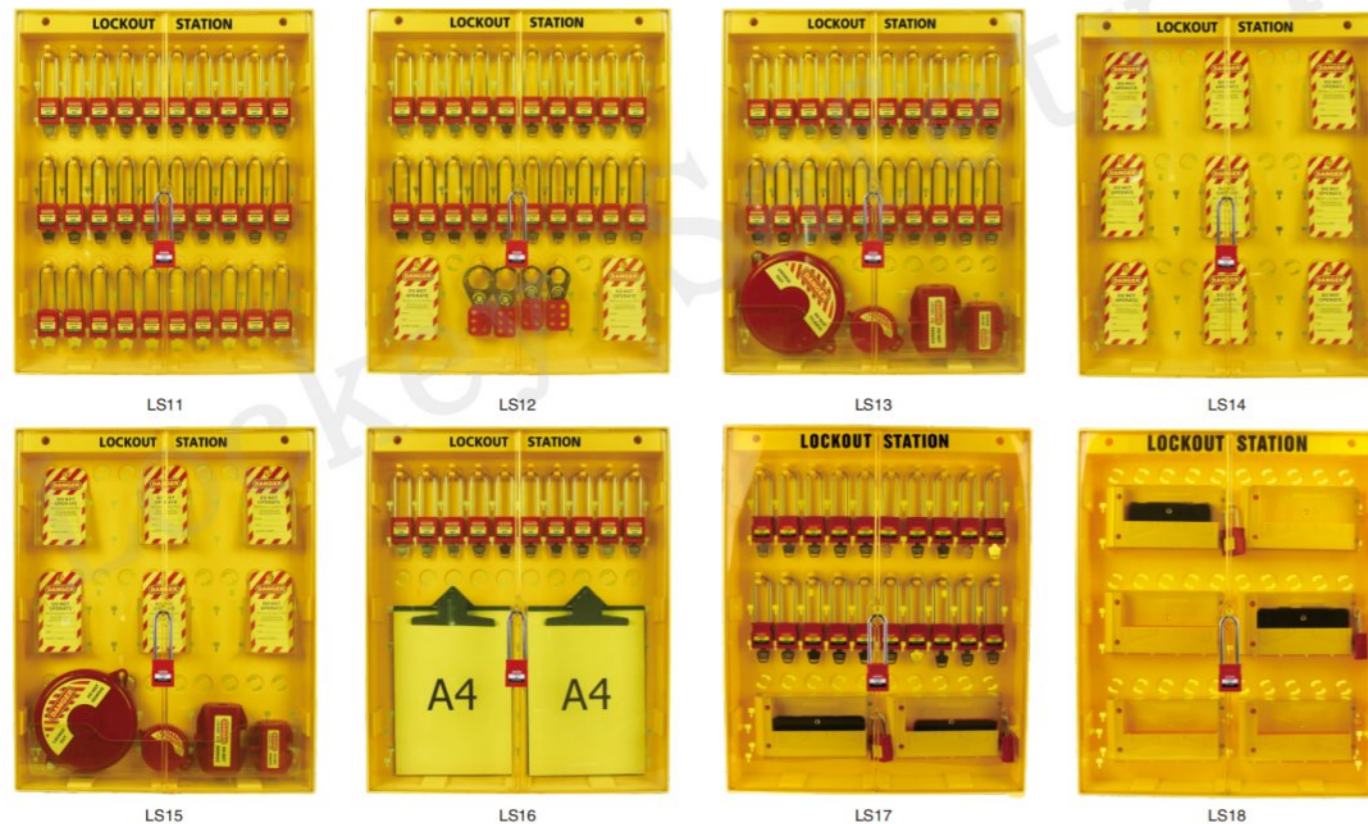

Eshop: <https://www.lockey.cz/>

**OPEN LOCKOUT STATION**

Part No.	Description
LS21	Accept 10–16 padlocks with 2 tag holders
LS22	Accept 10–16pcs padlocks, 2 hasps, and 1 tag holder.
LS23	Accept 20–32pcs padlocks.

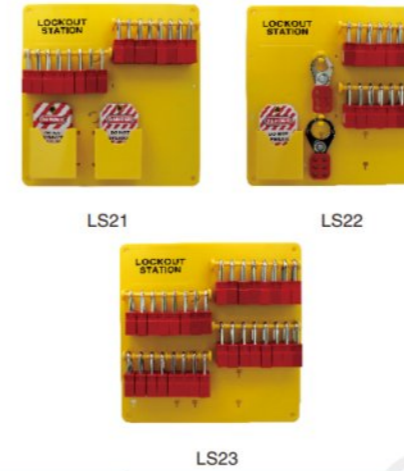

- Made from ABS, strong and durable.
- Accessories can be freely matched according to needs.
- Support customize the LOGO.
- The overall size: 380mm (W) × 380mm (H) × 10mm (D).

Part No.	Description
LS31	Can accommodate 60 padlocks.
LS32	Can accommodate 40 padlocks, 4 hasps and tags.
LS33	Can accommodate 40 padlocks and mini lockouts.
LS34	Can accommodate a number of lockout tags, 4 hasps.
LS35	Can accommodate 40 padlocks and 1 writing boards.
LS36	Can accommodate 20 padlocks and 2 writing boards.

**LOCKOUT STATION**



- The lockout station is made of engineering plastic ABS with transparent PC cover.
- The pc cover protects the inside lockouts from dust and missing.
- It can accommodate padlocks, hasps, lockout tags and some other lockout devices.
- There is an overall padlock hole to lock out the station and preventing the stored lockouts inside from unauthorized employees.
- The overall size: 603mm(W) × 600mm(H) × 66.8mm(D).



**LOCKOUT STATION**

Part No.	Description
LK12	10–lock station, 345mm(H)x345mm(W)
LK13	20–lock station, 595mm(H)x295mm(W)
LK14	36–lock station, 546mm(H)x597mm(W)



- Made from bright and durable acrylic with acrylic lock rails.
- Warning label can be customized.
- Can accommodate padlocks, tags, hasps.

Eshop: <https://www.lockey.cz/>



Part No.	Description
LS51	280mm(W)*400mm(H)
LS52	360mm(W)*540mm(H)
LS53	660mm(W)*520mm(H)
LS54	800mm(W)*650mm(H)
LS55	1220mm(W)*800mm(H)
LS56	1220mm(W)*800mm(H)

**LOCKOUT STATION**

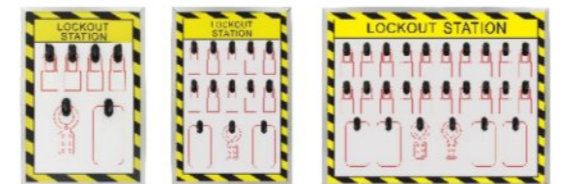

LS51 LS52 LS53

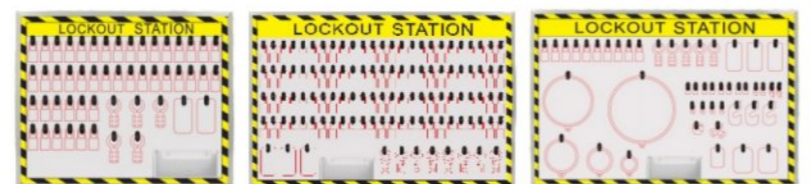

LS54 LS55 LS56

- Made of Chevron board, PVC and aluminum alloy.
- Shadow contour is convenient to inventory and storage.
- Shadows are status indicators, clearly showing which piece of equipment is in use.
- Can customize design and logo etc.

**PERMIT DISPLAY CASE**

Part No.	Description
LK51	305mm(W) x435mm(H)



- Made from surface high temperature spraying plastics treatment steel plate.
- Clear, impact-resistant window for viewing and protecting permit documents.
- Rubber seal protects documents from water damage in outdoor applications or during cleaning.
- Includes carrying handle for portability when not wall mounted.

Part No.	Description
LK52	305mm(W)x345mm(H)x90mm(D)

**GROUP LOCK BOX**



- Made from surface high temperature spraying plastics treatment steel plate.
- Clear, impact-resistant window for viewing secured key(s) during lockout.
- 12 numbered lock holes for personal safety locks.
- Includes removable lock caddy for easy transportation of equipment locks to isolation points during lockout.
- Removable key cup to collect and maintain visibility of secured key(s) during lockout, and easy retrieval of key(s) after release of lockout.

**PERMIT CONTROL STATION**

Part No.	Description
LK53	305mm(W) x780mm(H)x90mm(D)



- The LK53 Permit Control Station includes the LK51 Permit Display Case and the LK52 Wall Mount Group Lock Box.
- When used within various settings throughout a facility, the LK53 Series can improve the effectiveness and efficiency of group lockout while communicating the details and status of permit-to-work jobs.

Part No.	Description
LK81	208mm(W)x98mm(H)x99mm(D)

**PORTABLE KEY MANAGEMENT BOX**

- Made of engineering ABS plastic and polycarbonate.
- Can hang 6 keys, with 2 key put-in holes at the top part.
- With 16 padlock holes, support 16 person to manage it at same time.



Part No.	Description
PLK11S	365mm(W)x185mm(H)x140mm(D)
PLK11	408mm(W)x195mm(H)x185mm(D)
PLK11L	450mm(W)x245mm(H)x213mm(D)

**MAINTENANCE LOCKOUT TOOL BOX**



- Made of coated iron and engineering plastic PP.
- Warning words can be customized.



### LOCKOUT STATION

- The lockout station is made of engineering plastic ABS with transparent PC cover.
- Comes with predrilled holes for easy wall mounting when you want it to stay put and attachable handle when you need it on the go.
- Lockable clear plastic door provides instant visibility while protecting contents from damage, theft and loss.
- The overall size: 440mm(W) × 390mm(H) × 130mm(D).

Part No.	Description
PLK21	Can accommodate 24 padlocks.
PLK22	Can accommodate 12 padlocks, 4 hasps and tags.
PLK23	Can accommodate 12 padlocks and tags.
PLK24	Can accommodate 12 padlocks and 2 shelves of small lockouts
PLK25	Can accommodate 1 shelf of small lockouts and tags
PLK26	Can accommodate 3 shelves of small lockouts



### METAL PADLOCK STATION



Part No.	Description
PLS01	140mm(L) × 40mm(W) × 80mm(H), can accommodate 5 padlocks.
PLS02	270mm(L) × 40mm(W) × 80mm(H), can accommodate 10 padlocks.
PLS03	400mm(L) × 40mm(W) × 80mm(H), can accommodate 15 padlocks.
PLS04	530mm(L) × 40mm(W) × 80mm(H), can accommodate 20 padlocks.

- Made from heavy duty steel with durable powder coated finish treatment, which ensures longer life in manufacturing facilities.
- English warning label. Other language can be custom made.

Part No.	Description
PH01	Accommodate up to 12 padlocks

- Made from engineering plastic reinforced nylon molding.
- Can carry up to 12 padlocks at the same time.
- English warning label. Other language can be custom made.

### PORTABLE PADLOCK HANDY



### PORTABLE PADLOCK HANDY

Part No.	Description
PH02	Accommodate up to 12 padlocks.

- Made from durable industrial oxford fabric.
- Light, flexible devices can be carried on belt, accommodate up to 12 padlocks.
- With plastic spring for holding keys.
- The overall diameter is 183mm, lock hole diameter is 10mm.



### SAFETY PORTABLE LOCKOUT BAG



Part No.	Description
LB02	350mm(L) × 230mm(H) × 210mm(W)
LB03	390mm(L) × 290mm(H) × 210mm(W)

- Made from durable waterproof nylon fabric.
- Can custom made the sign on the lockout bag surface.
- With easy carrying hand straps and a shoulder strap.

Part No.	Description
LB21	200mm(L) × 130mm(H) × 55mm(W)
LB31	280mm(L) × 300mm(H) × 80mm(W)
LB41	240mm(L) × 160mm(H) × 100mm(W)
LB51	195mm(L) × 115mm(H) × 75mm(W)

- Made from water resisting polyester cloth.
- Light-weight and easy to carry or wear .
- Can customize the sign on the lockout bag surface.

### SAFETY BAG





## SAFETY PORTABLE LOCKOUT BAG

Part No.	Description
LB61	620mm(L) × 160mm(H) × 100mm(W)



- Made from water resisting polyester cloth.
- Light-weight and easy to carry or wear with the adjustable waist straps.
- The words on the bag can be customized.

## KEY BOX

Part No.	Description
KB24	207mm(W) × 320mm(H) × 54mm(D), 24 key holes
KB32	267mm(W) × 320mm(H) × 54mm(D), 32 key holes
KB48	267mm(W) × 475mm(H) × 54mm(D), 48 key holes
KB72	390mm(W) × 475mm(H) × 54mm(D), 72 key holes
KB96	390mm(W) × 632mm(H) × 54mm(D), 96 key holes
KB120	390mm(W) × 784mm(H) × 54mm(D), 120 key holes
KB150	437mm(W) × 780mm(H) × 54mm(D), 150 key holes
KB180	437mm(W) × 875mm(H) × 54mm(D), 180 key holes



- Made from aluminum with surface treatment.
- Can hold all kinds of keys, cards etc.

- Other capacities can be customized.

Part No.	Description
KT01	Label inside can be custom made

- Made from PE material, durable using.
- Comes with a writable white paper inside.
- Overall size: 58 × 21mm
- All colors available.



## KEY TAG

## KEY TAG

Part No.	Description
KT11	Customizable content and LOGO



- Aluminum material.
- External diameter: 38mm.

Part No.	Description
TP01	Labels can be customized

- Used on the PVC tag.
- Use cloth and paper to erase the script that the pen written.

## ERASABLE TAGOUT PEN



## DOCUMENT POUCH

Part No.	Description
PDH01	Plastic sleeve dimensions : 228mm(W) × 320mm(L)

- Constructed from durable, heavy duty PVC.
- Ideal for storing permits and isolation documents.







## LOCKOUT KIT

Lock out, stay safe.

Eshop: <https://www.lockey.cz/>

Part No.	Products	Description	Part No.	Products	Description
LG01		Lockout Station (LS01) x 1; Safety Padlock (P38S-RED) x 4; Lockout Hasp (SH01) x 1; Lockout Hasp (SH02) x 1; Lockout Tag (LT03) x 12; Some cable tie.	LG05		Padlock Handy (PH01) x 1; Safety Padlock (P38S-RED) x 12.
LG02		Lockout Station (LS02) x 1; Safety Padlock (P38S-RED) x 10; Lockout Hasp (SH01) x 1; Lockout Hasp (SH02) x 1; Lockout Tag (LT03) x 24; Some cable tie.	LG06		Lockout Bag (LB03) x 1; Safety Padlock (P38S) x 2; Laminated Padlock (LP01) x 1; Laminated Padlock (LP05) x 1; Lockout Hasp (SH01) x 1; Lockout Hasp (SH02) x 1; Gate Valve Lockout (SGVL01) x 1; Gate Valve Lockout (SGVL02) x 1; Gate Valve Lockout (SGVL03) x 1; Gate Valve Lockout (AGVL01) x 1; Ball Valve Lockout (ABVL01) x 1; Air Source Lockout (ASL04) x 1; Cable Lockout (CB01-6) x 1.
LG03		Lockout kit Box (PLK11) x 1; Lockout Hasp (SH01) x 2; Lockout Hasp (SH02) x 2; Safety Padlock (P38S-RED) x 4; Lockout Hasp (NH01) x 2; Cable Lockout (CB01-6) x 1; Valve Lockout (AGVL01) x 1; Valve Lockout (ABVL01) x 1; Breaker Lockout (CBL11) x 2; Breaker Lockout (CBL12) x 1; Breaker Lockout (TBLO) x 2; Lockout Tag (LT03) x 12.	LG07		Lockout Bag (LB03) x 1; Lockout Hasp (SH01) x 1; Lockout Hasp (SH02) x 1; Laminated Padlock (LP01) x 1; Laminated Padlock (LP05) x 1; Safety Padlock (P38S-RED) x 2; Plug Lockout (EPL01) x 1; Plug Lockout (EPL02) x 1; Breaker Lockout (CBL11) x 1; Breaker Lockout (CBL12) x 1; POS,PIS,POW x 1; CBL01-2,CBL02-2 x1; SBL03,SBL01x1; Pneumatic Lockout(ASL02) x1;
LG04		Lockout Bag (LB21) x 1; Lockout Hasp (SH01) x 1; Lockout Tag (LT03) x 2; Safety Padlock (P38S-RED) x 2; Breaker Lockout (CBL11) x 2; Breaker Lockout (TBLO) x 1.	LG08		Lockout Station (LK12) x 1; Safety Padlock (P38S-RED) x 10; Lockout Hasp (SH01) x 2; Lockout Hasp (SH02) x 2; Lockout Tag (LT03) x 12.

Eshop: <https://www.lockey.cz/>



Part No.	Products	Description	Part No.	Products	Description
LG09		Lockout Station(LK13) x 1; Safety Padlock (P38S-RED) x 20; Lockout Hasp (SH01) x 2; Lockout Hasp (SH02) x 2; Lockout Tag (LT03) x 24.	LG13		Lockout Station (LS13) x 1; Safety Padlock (P76S-RED) x 20; Gate Valve Lockout (SGVL01) x 1; Gate Valve Lockout (SGVL02) x 1; Plug Lockout (EPL01) x 1; Plug Lockout (EPL01M) x 1.
LG10		Lockout Station(LK14) x 1; Safety Padlock (P38S-RED) x 36; Lockout Hasp (SH01) x 2; Lockout Hasp (SH02) x 2; Lockout Tag (LT03) x 48.	LG14		Lockout Station (LS14) x 1; Lockout Tag (LT03) x 108.
LG11		Lockout Station (LS11) x 1; Safety Padlock (P76S-RED) x 30.	LG15		Lockout Station (LS15) x 1; Lockout Tag (LT03) x 72; Gate Valve Lockout (SGVL01) x 1; Gate Valve Lockout (SGVL02) x 1; Plug Lockout (EPL01) x 1; Plug Lockout (EPL01M) x 1.
LG12		Lockout Station (LS12) x 1; Safety Padlock (P76S-RED) x 20; Lockout Hasp (SH01) x 2; Lockout Hasp (SH02) x 2; Lockout Tag (LT03) x 24.	LG31		Lockout Bag (LB31) x 1; Lockout Tag (LT02) x 10; Safety Padlock (P38S-RED) x 1; Aluminum Padlock (ALP38) x 1; Breaker Lockout (CBL11) x 1; Breaker Lockout (CBL12) x 1; Breaker Lockout (CBL13) x 1; Lockout Hasp (SH01) x 1.

Part No.	Products	Description	Part No.	Products	Description
LG41		Lockout bag (LB41) 1PC; Safety padlock (P38S-RED) x 1 Safety padlock (PC175-RED) x 1; Lockout tag (LT03) x 12; Breaker lockout (CBL32) x 2; Breaker lockout (CBL31) x 1; Lockout hasp (SH01) x 1;			
LG51		Lockout bag (LB51) x 1; Safety padlock (P38S) x 2; Lockout tag (LT03) x 2; Lockout hasp (SH01) x 2; Ribbon x 2;			
LG61		Lockout bag (LB61) x 1; Safety padlock (P38S) x 1; Safety padlock (PC175) x 1; Breaker lockout (CBL32-S) x 2; Breaker lockout (CBL31-S) x 1 Lockout hasp (SH01) x 1; Lockout tag (LT03) x 12; Ribbon;			